

DELTA V4



MADE IN FRANCE

USER'S MANUAL



TABLE OF CONTENTS

TECHNICAL INTRODUCTION — Page 02	
LIST OF PARTS - ASSEMBLY — Page 03	WIRELESS HEADPHONES
	Menu — Page 25
	Discrimination-Sensitivity-Ground
	Frequency-Tones-Volume-Coil
USE	Pairing with a new coil — Page 26
Remote control — Page 05	Delete coil — Page 26
Factory programs, Description — Page 06	Factory Programs — Page 27
Starting up — Page 07	Save or delete a modified program — Page 27
	Replacement of the backphone — Page 27
MENU	Pairing / Remove PINPOINTER — Page 27
Discrimination — Page 08	
Discrimination IAR (Gold Field) — Page 09	POWER SUPPLY - BATTERIES
Sensitivity — Page 09	Battery status — Page 28
Frequency — Page 09	Battery life — Page 28
Iron Level — Page 10	Charging time and charging progress — Page 28
Reactivity — Page 10	Charge — Page 29
Audio Response — Page 12	Battery durability — Page 29
Notch — Page 12	Replacement — Page 30
	Precautions — Page 30
GROUND	
General — Page 12	EXPERT
Manual Mode — Page 13	Multi-Tones — Page 31
Pumping Mode — Page 14	Pitch — Page 31
Prog.10 Gold Field — Page 14	Full Tones — Page 31
Tracking Mode — Page 15	Multi-Tones, thresholds and tones — Page 32
Beach Mode — Page 15	TX Power — Page 32
	Audio Overload — Page 33
NON-MOTION — Page 16	Frequency shift — Page 33
	Silencer — Page 34
OPTION	Multi-Notch — Page 34
Pinpointer — Page 17	Notch Ground — Page 35
Remote control programs — Page 19	
Coils — Page 19	PRACTICAL INFORMATION — Page 35
Pairing with a new coil — Page 20	PRECAUTIONS FOR USE — Page 37
Delete coil — Page 20	TROUBLESHOOTING AND SOLUTIONS — Page 38
Configuration — Page 21	SPECIFICATIONS — Page 39
Speakers - Back light - Contrast — Page 21	ACCESSORIES — Page 40
Clock setting - Profile — Page 21	SPARE PARTS — Page 41
ID Norm — Page 23	FACTORY PROGRAMS — Page 42
Smartphone app — Page 23	YOUR SETTINGS — Page 44
Update — Page 23	RECOMMENDATIONS / LAW — Page 46
	DECLARATION OF CONFORMITY — Page 46
	WARRANTY — Page 48

CONGRATULATIONS ON THE PURCHASE OF YOUR XP METAL DETECTOR AND WELCOME TO THE WORLD OF RESEARCH AND EXPLORATION!

You have invested in a high-tech metal detector capable of exceptional performance, which has been designed and developed in France. You are therefore helping our Company to further expand our research in the field of metal detecting and we thank you for your contribution.

TECHNICAL INTRODUCTION

The XP Dēus is innovative in terms of metal detector design as it offers a unique design based on three elements communicating via a digital radio link. The search coil, remote control and headphones have each been made independent through the integration of very compact, high-capacity lithium batteries.

An ultra-miniature electronic circuit, incorporated into the search coil, digitises and analyses the signals. Data is then sent to the headphones and remote control in real time via a digital radio link. With this method, the signal is processed at source and not conveyed via a wire link, which greatly improves data quality.

Incorporating components from leading-edge technologies such as scientific instrumentation has enabled us to produce a powerful, rapid, lightweight, compact and fully controllable digital detector.

Whether you are an experienced user or a beginner, the Dēus lets you decide whether or not to modify any of its settings. Powerful pre-configured factory programs enable all users to get started immediately, while expert detectorists can choose more advanced parameters via the intuitive interface.

What is described in this manual as the "Remote Control" is in fact the user interface, known as the 'control box' on conventional detectors. It enables the detector's many functions to be precisely adjusted via a graphical interface. It can also receive program updates (via internet) through its USB socket.

The Dēus is also exceptional in being able to function without the remote control, with just the coil and the wireless headphones, for an even more compact, lightweight configuration !

Like the remote control, the headphones contain all the components needed for detection, they are a genuine control unit in themselves, but on an ultra-miniature scale and rain proof. They take over in the absence of the remote control for adjusting the detector settings. With the headphones you can turn the Dēus on and off, change the main detection settings such as sensitivity, discrimination, ground balance, tone, frequency (from 4 to 80 kHz depending on the selected search coil), volume, etc. as well as selecting the factory programs or those previously configured with the remote control !

Performance is identical whether you are searching with or without the remote control !

Lastly, the new patented XP stem has the combined advantages of an S-shaped stem and a straight telescopic stem. It enables you to deploy or fold away the device in just a few seconds, and to change the coil in an instant. Its user-friendly design ensures comfort and convenience for the user: length adjustable by millimetre increments, improved operating angle and shaped rubber handle for a firm, controlled grip.

So now you're ready for a new adventure!

LIST OF PARTS

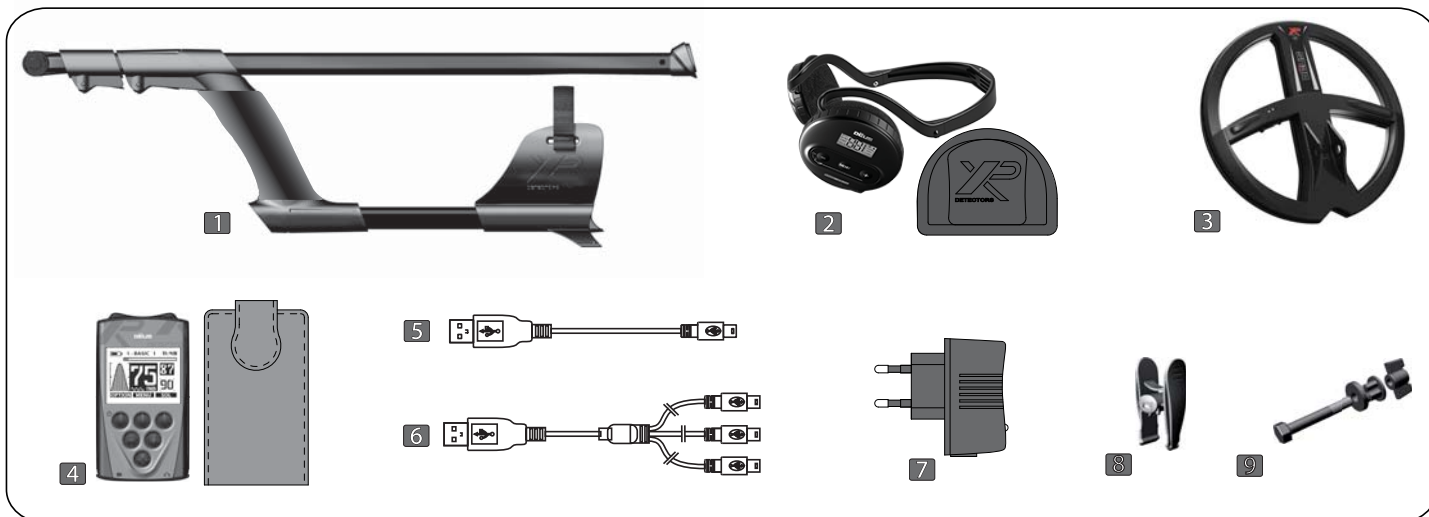

The box for your Dēus metal detector (subject to version purchased) contains the following parts:

- 1 One assembled fully telescopic stem
- 2 One set of wireless headphones with storage case (subject to version purchased)
- 3 One search coil with coil cover
- 4 One user interface (remote control) with case
- 5 One connection cable: USB / one mini-B plug (Only when purchased with remote control)
- 6 One connection cable: USB / three mini-B plugs
- 7 One mains power supply transformer-charger
- 8 One connection clamp for recharging the coil
- 9 One set of fastenings (2 screws, 2 wing nuts, 1 washer, 1 spacing washer)

ASSEMBLY

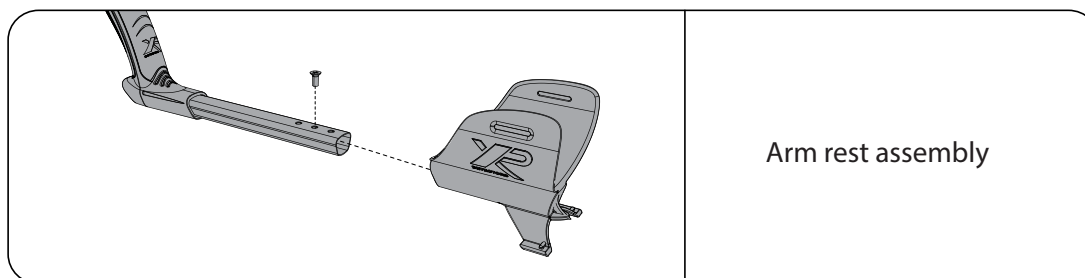

Arm rest assembly

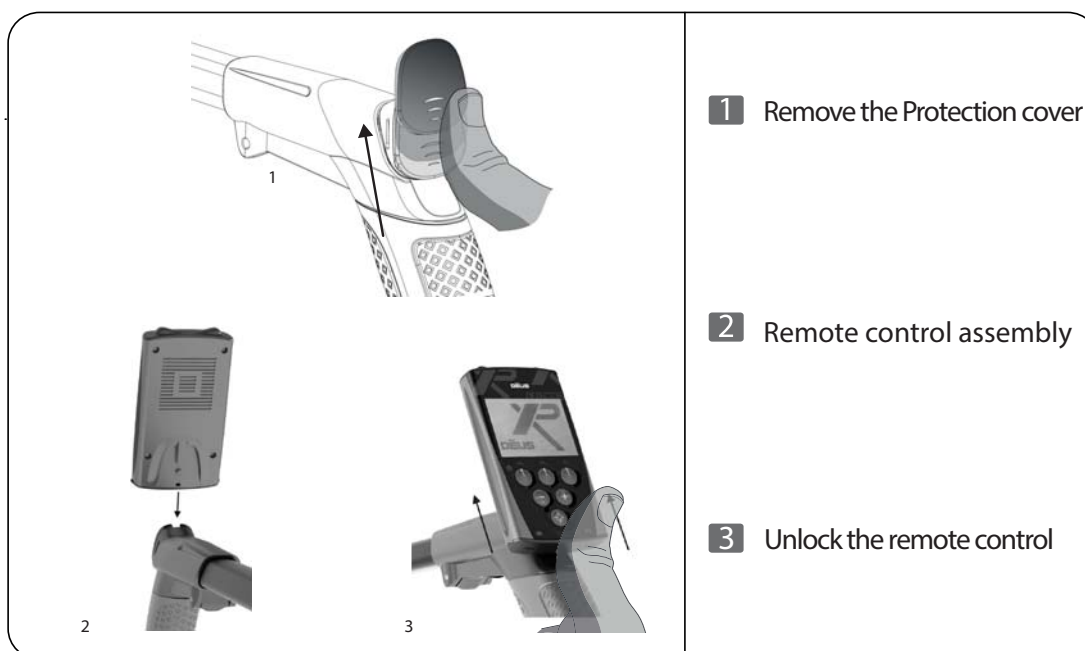

- 1 Remove the Protection cover
- 2 Remote control assembly
- 3 Unlock the remote control

STANDARD COIL

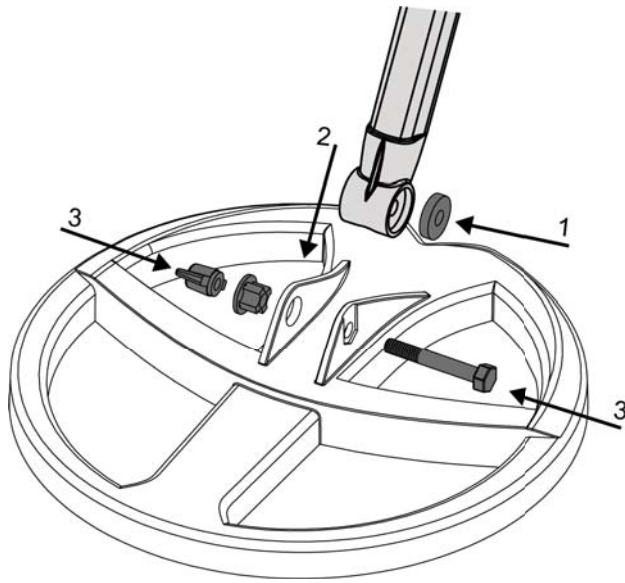

Fitting the coil on the stem

- 1 Insert the single rubber washer in the lower shaft.
- 2 Line up the lower stem with the coil fit the two parts together.
- 3 Install bolt and nut.

HF COIL

01

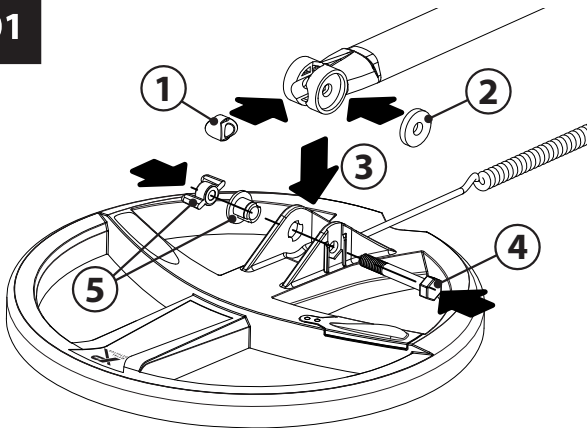

02

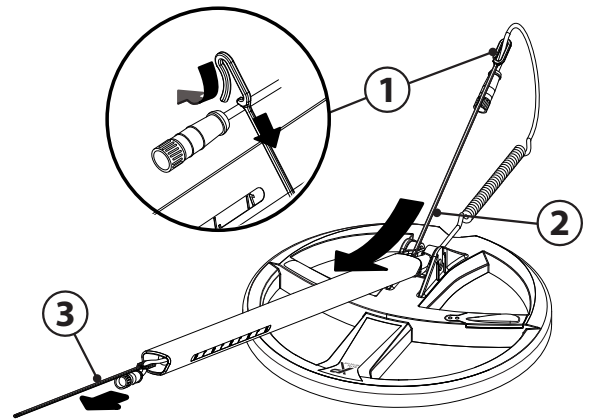

03

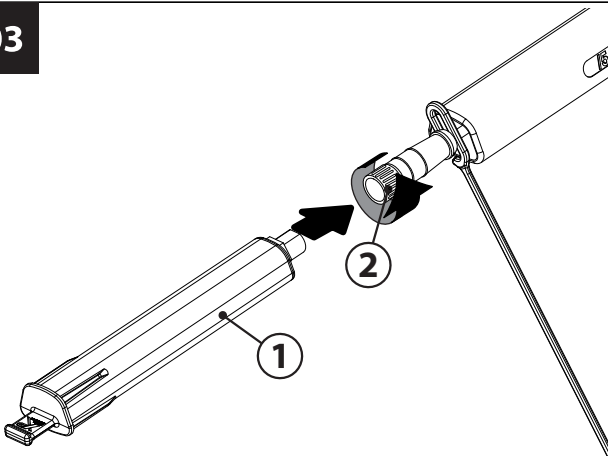

04

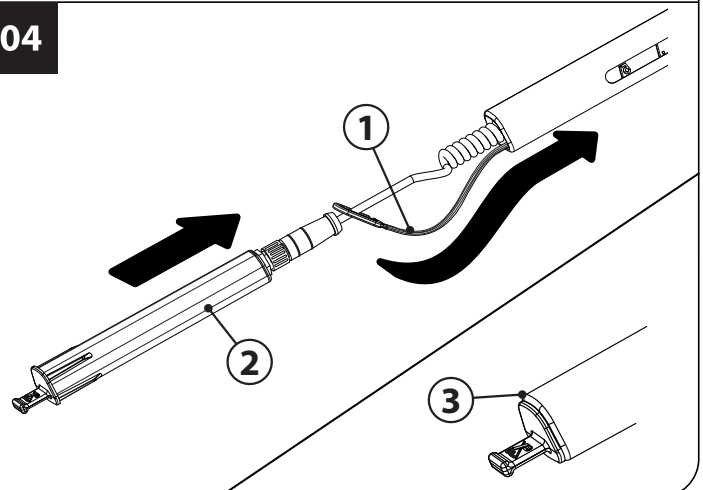

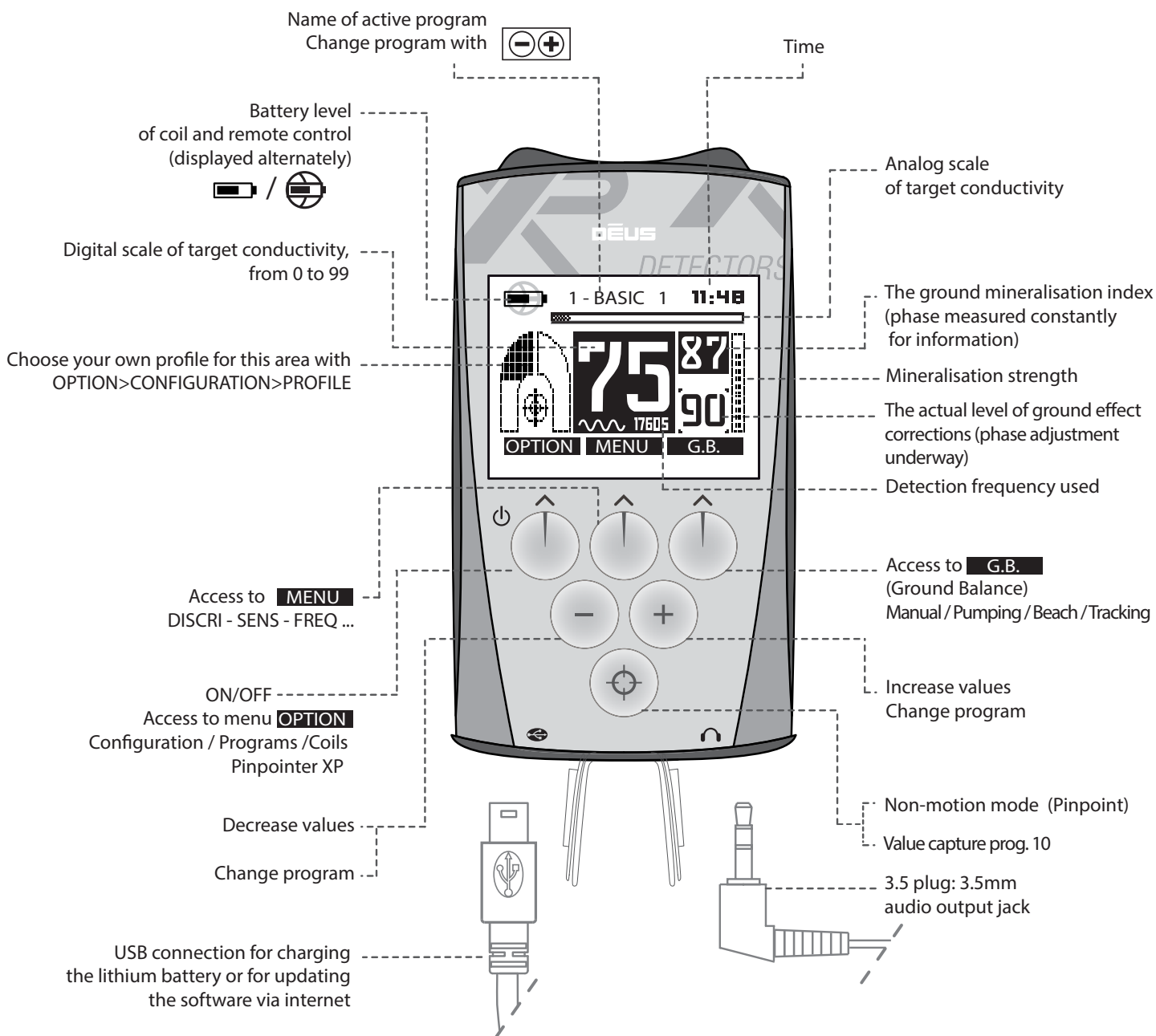

Example of secondary page

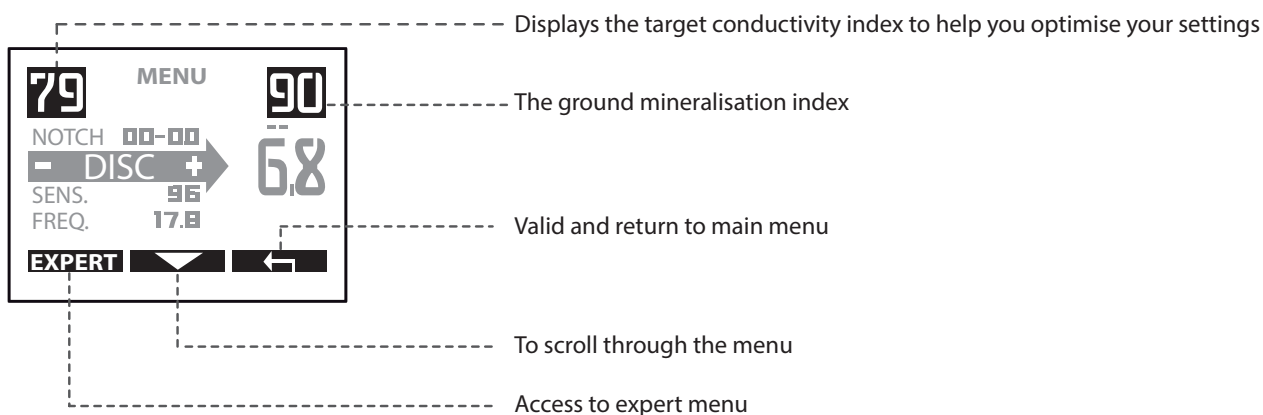

- 1 - BASIC ----- General use.
- 2 - GM POWER ----- Similar settings to the XP Gold Maxx Power detector, powerful and fast.
- 3 - DEUS FAST ----- More selective to small targets in iron-infested ground and deeper on mineralised ground
- 4 - PITCH ----- Responsive pitch that varies in frequency and amplitude according to the signal's strength.
- 5 - G-MAXX ----- Medium speed, particularly effective for large masses and highly conductive coins.
- 6 - DEEP ----- Pro setting for locating deep targets, with moderate discrimination and specific signal processing
- 7 - WET BEACH ----- Wet beaches, although in situ adjustments are needed for the ground effect, either by pumping or manually adjusting. (pg 13).
- 8 - DRY BEACH ----- Suitable for dry sand.
- 9 - HOT ----- HOT «The Pro setting» this is a find everything program, based on the Full Tone audio mode with a very low discrimination. Hot is a very interactive program offering excellent feedback and target information.
- 10 - GOLD FIELD -----
 GOLD FIELD uses another detection method designed for searching highly mineralised ground which is often where gold nuggets are found. In these conditions, targets can be seen as ground mineralisation or ferrous objects, especially when they are deep. To go deeper in these difficult conditions, the "Gold Field" program uses a true All Metal mode that allows you to accept a zone of ground that is usually not available. Instead of rejecting all the ground values below a predefined value (as on conventional detectors), it rejects only the specific value of ground in which you are searching, which means you have to adjust precisely. To facilitate the ground balance (essential in this program), *pressing ⊕ will make an immediate acquisition of the ground value within one or 2 pumps of the coil.

In this program certain settings are not active or are replaced by the another specific setting such as:

- The IAR discrimination (Iron Amplitude Rejection): A range of discrimination that can be applied from 0 to 5. It applies only to targets that produce strong signals – typically shallow ferrous items. It will not reject deeper targets which may come across as ferrous when they are buried in mineralised ground to ensure good targets are not rejected by mistake.

* Immediate acquisition of the ground value (Grab) is performed simply by pressing ⊕ (while pumping the coil to & from the ground).

Note : The digital target display is active, this allows the operator to work in All Metal mode with a visual recognition (valid on shallow targets).

STARTING UP

After charging your device. (pg 29)



1
Switch on the remote control

(after extending stems and holding the coil away from the ground and any metal)



2
Validate or not the use of the loudspeaker

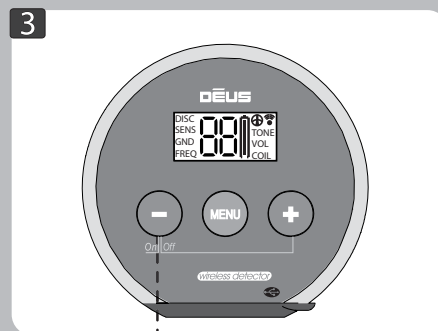

3
Switch on the headphones





The LED on the coil gives 20 long, successive flashes to indicate that it is waking up and recalibrating.

Once recalibration is complete, the coil becomes operational and its LED flashes every second.



By default you begin by using the **1 - BASIC** factory program which is suitable for general use.

If you wish to test one of the 10 other factory programs,

simply scroll through them with  

To switch off the Dēus

1 Hold down Power  on the remote control.

2 Press left- and right-hand buttons simultaneously   on the headphones.

Note: Do not switch the Dēus on when the coil is near metal, inside a car, or when the stem is collapsed, as this may interfere with calibration and lead to abnormal performance. If this should occur, switch off and move away from any metal masses before switching it on again. Nevertheless, this does not represent any risk to the equipment or its electronics. But may give abnormal results !

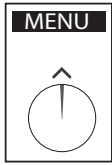

Configuring the main detection settings.

1 Press **MENU**

2 Scroll through the menu by pressing

DISCRIMINATION

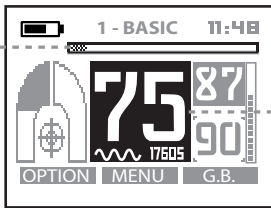
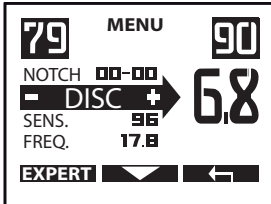

1 Adjust the Discrimination level (from -6.4 to 99) with

2 Exit with to return to the main menu.

Discrimination enables undesirable targets to be rejected by raising or lowering a threshold below which certain metals are differentiated. The conductivity scale (0 to 99) for metal targets shown below will help you better understand the discrimination range and its limits, and see how it corresponds to the **digital display** of target conductivity on the remote control main menu.

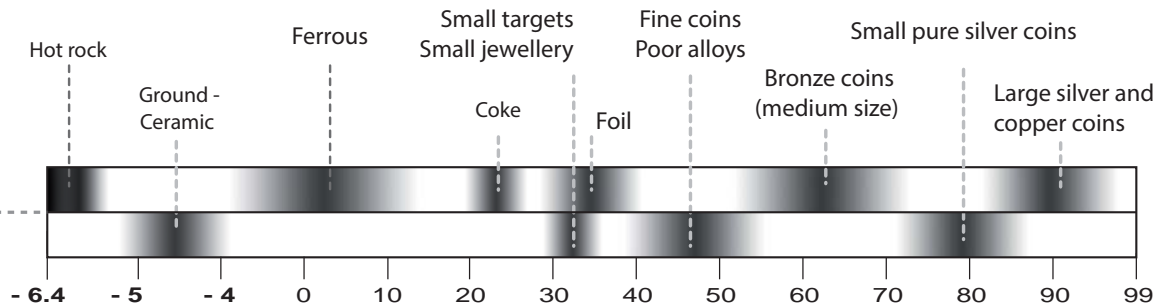

Increasing the discrimination value enables you to gradually reject any target whose conductivity is lower than the setting. For example, if you tune the discrimination level to 10, you will reject iron with a value of between 0 and 10. If you tune it to 40 you will also eliminate small pieces of aluminium foil whose conductivity is less than 40. If you wish to reject other rubbish with higher conductivity, such as pull tabs from aluminium drinks cans, lead shot or copper hunting cartridges (whose conductivity is 60-75), you must also be prepared to accept the elimination of certain good metals with similar conductivity. If you are particularly bothered by contamination registering as highly conductive on the digital screen, and you still wish to reject it, it is better to do so using the NOTCH rejection setting.

Two alternatives involve selecting a low level of discrimination, between 5 and 10, then using either:

- 1/ The digital target display to more or less visually discriminate a target category.
- 2/ The Multi-tone mode to discriminate undesirable targets using a selected audio tone.

In both cases the decision then lies with you on whether or not to dig.

Note : Depending on the frequency setting used, a target's conductivity is perceived differently by the detector. The digital conductivity display may therefore vary depending on the frequency.

Note : The 0 to 10 range relates to the rejection of iron. To achieve greater precision in this range there is a digit after the decimal point (from -6.4 to 9.9).

Note : In several menus, particularly at the top left of the Discrimination screen, a reminder of the target conductivity index is displayed, which helps you when adjusting the discrimination level.

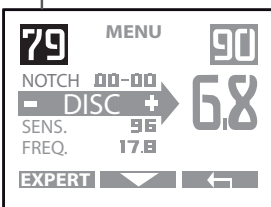

DISCRIMINATION IAR (Prog.10 GOLD FIELD)

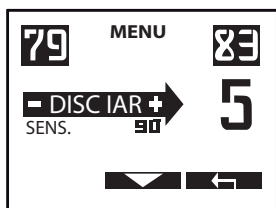

The program N°10 GOLD FIELD uses another discrimination method, called IAR (Iron Amplitude Rejection): the range of discrimination can be applied from 0 to 5. It applies only to targets that produce strong signals – typically shallow ferrous items. It will not reject deeper targets which may come across as ferrous when they are buried in mineralised ground, to ensure good targets are not rejected by mistake. Higher discrimination values, enable the detector to reject deeper ferrous. Gold nuggets buried deep in mineralised ground can generate a similar signal to a ferrous item, so in this case it is better to reduce the level of discrimination.

SENSITIVITY

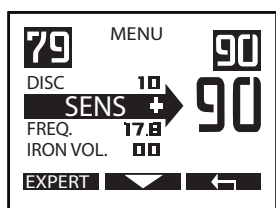

- 1 Adjust the Sensitivity level (from 0 to 99) with
- 2 Exit with

Sensitivity is often simplistically described as the setting which adjusts the device's power level. However this is incorrect. As its name indicates, it actually determines the device's sensitivity level. It reacts after receiving a signal via the receiver coil. Nevertheless, the results are somewhat similar in practice, as increasing a device's sensitivity enables it to detect the presence of more distant targets. However it must be noted that this setting has no effect on the power emitted.

The most commonly used sensitivity levels range from 70 to 90. It may be necessary to reduce the level if there is too much interference, as is often the case near overhead or buried power lines, fences, radio-relay stations, mobile telephones, computers, televisions, etc.

Do not test your device in your home as there is considerable electromagnetic and metal interference in urban environments.

FREQUENCY

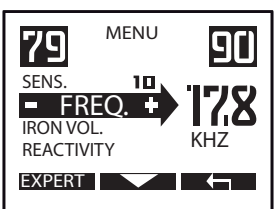

- 1 Scroll through the frequencies with
- 2 Exit with

The DēUS gives you the choice of several detection frequencies from 4 to 80 kHz depending on the selected coil. The frequencies enable you to adapt your research more closely to the characteristics of the ground and desired targets.

Here is a brief list of the most likely targets that may be detected according to the frequency:

4 kHz	Large, mainly ferrous and non-ferrous masses. Coins of sufficient conductivity and size. All other medium or relatively small targets in non-mineralised ground relatively uncontaminated by iron. Good for ferrous masses and militaria.
8 kHz	General use. Coins and large masses, militaria. Medium and small targets in low-mineralised ground.
12 to 15 kHz	General use, small coins. Coins of all sizes in medium to highly mineralised ground.
18 to 80 kHz	Small coins made from any alloy (gold, silver, copper, etc.) and very fine coins, low conductivity target, gold nuggets, lead, rings, thin metal, aluminium foil. Discriminates (distinguishes) coke more easily. Can be more unstable on non-mineralised and moist ground

Note : If you are just starting out, the 8 kHz frequency is a good compromise for general use. On a wet beach the 18 kHz frequency will be better at finding small gold jewellery such as chain necklaces and bracelets that are usually so difficult to detect.

IRON VOLUME

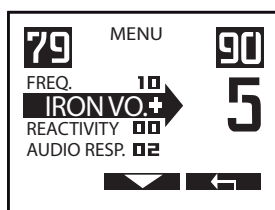

1 Adjust the Iron Volume (from 0 to 5) with

2 Exit with

You have the option of controlling the volume of the low-pitched tone which generally corresponds to iron. Depending on the circumstances, sometimes reducing the iron volume can make the user more aware of non ferrous targets.

On the other hand, some users prefer to make the low-pitched signals from iron more audible, as they know that some good targets at the detector's depth limit in mineralised ground can sometimes generate a low-pitched sound.

- At 0 the low-pitched tone is cut off.

- At 5 the low-pitched tone will have a sound level equivalent to other non ferrous targets.

Note: If the discrimination threshold is too low, 0 or 2 for example, most iron will generate not low- but medium-pitched tones, as you will practically be in the All Metal mode. In this case, the iron level setting will have very little function.

REACTIVITY



1 Adjust the Reactivity from 0 to 5 with

2 Exit with

The Reactivity is a vital setting that determines the detector's performance in terms of how quickly it analyses the signal from detected objects and its ability to separate the signal response from two targets located close together. This is also known as Recovery speed.

If the soil contains a great deal of iron, hot rocks or other mineralised debris, soil penetration can be drastically reduced. In these conditions, The Dēus enables you to select a high degree of reactivity which will help you speed up the analysis of signals.

On the other hand, if the ground is "clean", it is better to reduce the Reactivity and sweep slowly, in order to make the machine more sensitive to deep masses and obtain better soil penetration.

Users familiar with the Gold Maxx Power have already experienced the advantages of the XP Reactivity (recovery speed). And even though the Dēus is a particularly fast and selective detector, you now have the option of adjusting the reactivity setting to make it even more selective!

To help you better understand the reactivity levels available, you should note that the reactivity of most detectors on the market, generally only have an equivalent to level of 1 compared to the the Dēus.

The Gold Maxx Power has a reactivity equivalent to level 2 of the Dēus.

Most likely finds with the recommended settings are as follows:

0	Large masses and coins, in ground uncontaminated by iron.
1	Large masses and coins, in ground with little iron contamination, and general use.
2	General use, and mineralised soils contaminated with iron.
2.5	General use, difficult soils contaminated with iron
3	Difficult soils contaminated with iron, hot rocks, etc.
4/5	Very difficult soils, highly contaminated with iron and hot rocks.

REACTIVITY continued...

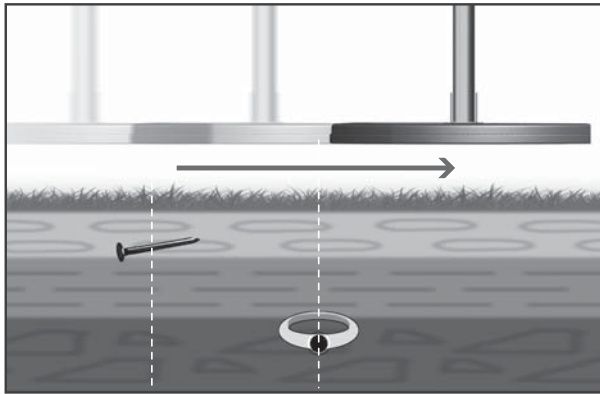

Example

Passing the coil over an iron object close to the surface then over a good metal target (ring).

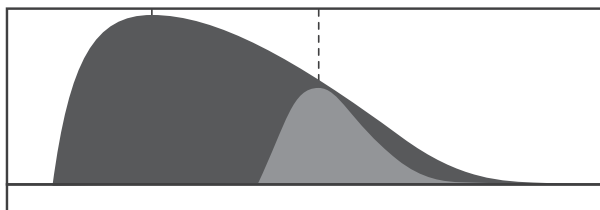

With a low Reactivity level, the iron is detected for a longer duration, to the extent that it completely hides the ring.

No sound

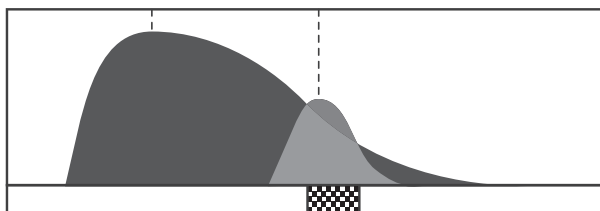

With a medium Reactivity level, you begin detecting the ring. The audio signal partially indicates the target.

Short sound

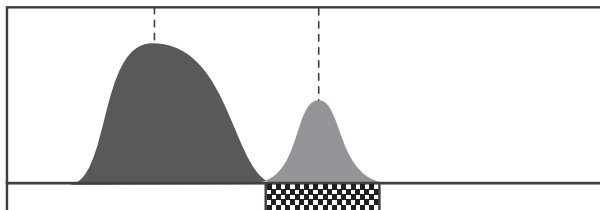

A high Reactivity level enables you to distinguish the ring completely from the iron. The audio signal fully indicates the target.

Full sound

REACTIVITY

In terms of pure performance, the greatest detection ranges are obtained with low reactivity levels. However, you will find more targets and will detect deeper on mineralised ground with medium or high reactivity levels.

For optimum performance adjust your reactivity to suit your search conditions.

Depending on the reactivity level, you will notice that the length of the audio signal varies when it passes over a target:

Low reactivity (0 to 2) = long sound



High reactivity (2.5 to 5) = short sound



Evidently the length of any false signals (the crackling of iron for example) will vary proportionately as well.

You are therefore advised not to constantly change the reactivity level, as this may interfere with your ability to distinguish good and bad sounds.

AUDIO RESPONSE

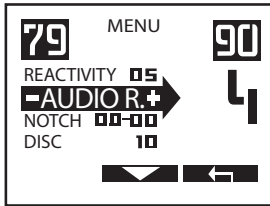

- 1 Adjust the Audio Response from 0 to 7 with
- 2 Exit with

The Audio Response enables you to amplify the volume of deep targets. It gives the impression of greater power, however it does not provide any additional depth as this setting only affects the sound curve (the dynamic range of sounds). Lower Audio response levels give a good perception of depth

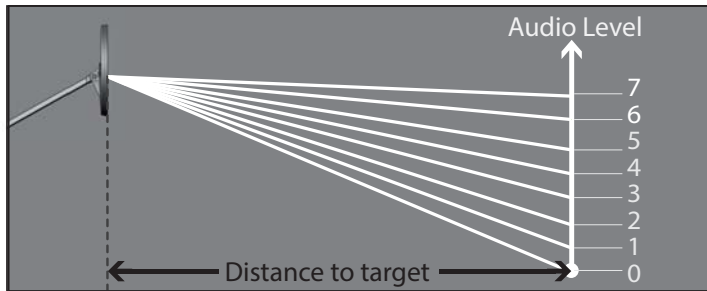

Note : By amplifying small signals you will also be amplifying small spurious false signals.

Note : By increasing the sound response you will compress the dynamic range and thus reduce the appreciation of a target's depth.

NOTCH

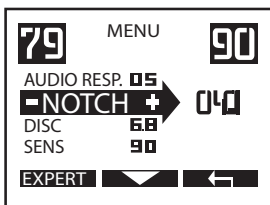

The Notch complements the discrimination: it enables a "target window" to be rejected whereas discrimination rejects all targets below a selected threshold. For example, if you detect a redundant, undesirable target in the ground, you can decide just to reject the corresponding conductivity group and continue to detect targets with a conductivity higher or lower than those in the group.

- 1 If the reference target has a conductivity of 37, adjust the Notch value to 34-40 using . All targets with a conductivity between 34 and 40 will then be silenced.
- 2 Exit with

Note : By default, the width of the rejection window is 6 points.

GROUND

The different levels of soil mineralisation you encounter when prospecting can sometimes affect the performance of your detector. For example, this may be due to natural magnetic mineralisation such as iron oxide, hot rocks and magnetite, or sporadic mineralisation from sites of former human settlement (also magnetic): hearths, pottery, hot rocks, slag, etc. At the seashore this may also involve mineralisation ranging from magnetic grade (black sand) to electrical conductor grade (salt water) depending on the beach or region.

If you are an experienced detectorist you may wish to optimise your searches to achieve better penetration in some of these mineralised soils.

In magnetic ground with relatively uniform mineralisation, a setting which is adjusted according to the ground effect will improve penetration by reducing the amplitude of the ground signals sent back by the receiver circuits. This 'adapted setting' involves adjusting your ground balance value to the average value of the ground being detected, while adding 1 so as not to hear the ground signals as much. The tracking and pumping modes do this automatically if the ground conditions allow it. With the Prog.10 Gold Field it is vital to set the machine exactly to the value of the ground.

General features

⚠ As the ground balance setting is the one requiring the most experience, we recommend that you read this chapter and use the different ground balance modes carefully, while acquiring your own experience of the ground. By default, remain in manual mode at level 90 for inland or dry sand. On wet beach reduce the level from 25 to 27.

Note : If the ground is not mineralised (see below the bargraph : Mineralisation strength) there is no need to adjust your ground balance to a level other than 90: since the ground does not send back any significant spurious echo, the performance will be optimal even at level 90 and you will reduce interference resulting from knocks to the coil.

On the main menu, two values are permanently displayed:

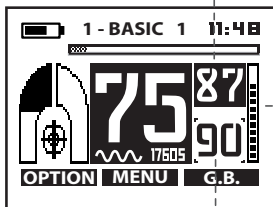

The ground mineralisation index (phase measured constantly for information).

Mineralisation strength. The higher this value, the more mineralised the ground is. Pump the coil up and down several times to evaluate the mineralisation strength. If the level is low, there is less of a need to make any adjustments.

The actual level of ground effect corrections (phase adjustment underway).

GB



1 Press Ground

4 modes are available:

MANUAL - PUMPING - TRACKING - BEACH (ON / OFF)

MANUAL Mode

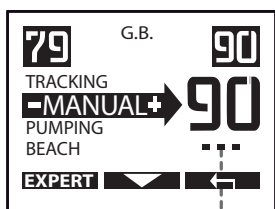

1 Go to **Manual** with

2 Adjust with

3 Exit with

You can manually adjust the ground rejection levels from 60 to 95 (Beach Off mode) or from 0 to 30 (Beach On mode)

Each ground rejection level from 60 to 95 receives additional units of fine adjustment to allow better ground tracking.

By reducing G.B towards 87 you will begin detecting hot rocks, and knocks to the coil may result in false signals. Even lower, between 75/85, pottery and the ground itself will begin interfering with your device.

Note : If you are inexperienced in working with ground effects, we strongly suggest that you limit yourself to a Ground Balance level of 90, which is the default setting, and is the most stable reference level recommended for inland ground. Levels lower than 90 will result in increasing instability.

PUMPING Mode

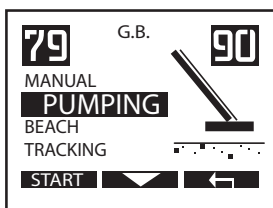

1 Go to **Pumping** with

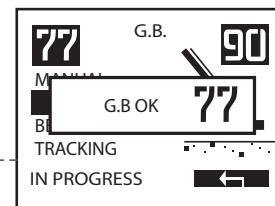

2 Press **START** and pump the coil on the ground several times until you obtain the display **G.B OK**

3 Exit with

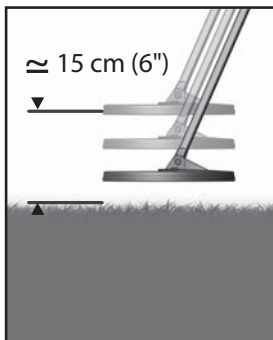

Pumping is a semi-automatic process which allows you to adjust the ground balance in a zone that you wish to search and have determined it as being an overall average soil type. Henceforth, the measured value of the ground is entered into the memory and used as the new active ground balance value.

If this value is unsuitable, or if it generates too much instability, you can repeat the process in a different zone or switch to manual mode adding several extra rejection points.

Note : If a metal target is detected while you are pumping, the Dēus will recognise this and display the message "**GB FAIL**". It will then retain the previous ground balance value. This problem is generally caused by iron being present. If this is the case then move to another location and restart the pumping

Note : In low- or non-mineralised ground, there is no need to adjust the ground balance and you are advised to remain on 90 for greater stability.

PUMPING Mode PROG. 10 GOLD FIELD

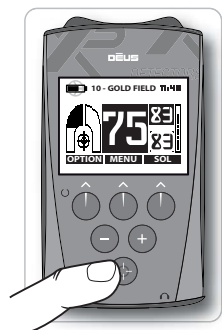

The program 10 GOLD FIELD is adapted specifically to search for gold nuggets in mineralised soils or likely gold areas. These areas are difficult to prospect with conventional detectors. The reason for this being the presence of ferromagnetic metals, they hide gold nuggets. Program n°10 GOLD FIELD uses another technique different from conventional detectors which cannot achieve an accurate ground balance in such extreme conditions.

You have the possibility to ground balance using the remote control or the headphone.

Controlling via remote control

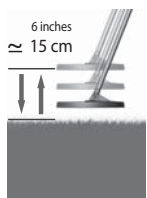

Press to grab the ground value while pumping the coil on the ground to calibrate and stabilise the DEUS. The number on the lower right of the screen shows you the new ground value.

Restart the operation if the ground changes or it becomes unstable.

Controlling via the headphone

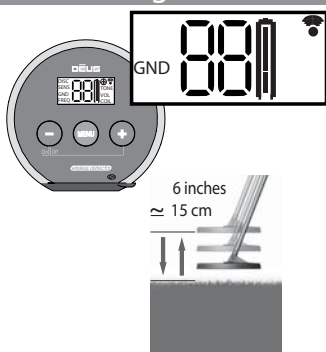

- 1 Press to reach Program (P1...), Select Program 10 (P 10) with or
- 2 Press to reach "GND".
- 3 Press while pumping the coil on the ground to grab the ground value.

Restart the operation if the ground changes or it will becomes unstable

TRACKING Mode

1 Go to **Tracking** with

2 Exit with

In this mode, the Dēus repeatedly scans the ground and digitally filters the extracted signals to determine the mean value on a continual basis. This mode may be useful in soils with relatively uniform mineralisation, and where the mineralisation varies gradually from zone to zone, which is often the case in naturally mineralised ground. In this case, the Dēus automatically readjusts the ground balance according to the most recent value measured.

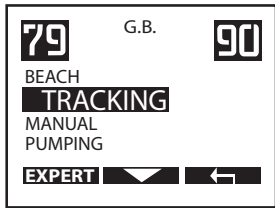

However, in ground where mineralisation is a result of human presence (ancient settlements, for example) this mode may be unsuitable due to ever changing ground conditions. Indeed, within the same sweep of just one meter, a considerable variety of ground conditions may be encountered, ranging from one extreme to the other (values between 70 and 90): hot rocks, brick, slag, pottery interspersed with soil that is neutral or characterised by diverse mineralisation. This may be to such an extent that any mean value would be meaningless. You must then determine an acceptable level of rejection for the ground based on your own experience of the site, your detection methods and the interference that you are prepared to tolerate.

Note : This mode is not available in Beach mode, as the Pumping mode is more effective.

Note : Low ground balance levels also generate the clearest signals on certain irons targets that are already difficult to eliminate.

BEACH Mode

1 Go to **Beach** with

2 Choose **YES** (00-30), with

Activates calculation of the ground balance on the zone corresponding to highly saline wet ground, so as to reduce interference caused by conductive salt water. After selecting Beach ON, you need to adjust the ground balance manually or by pumping on the wet zone concerned, in order to cancel out the ground signal.

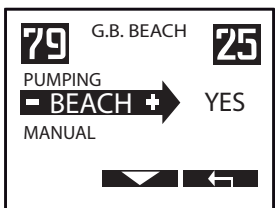

3 Go to **PUMPING** or **MANUAL** with

Press **START** and pump the coil on the ground several times until you obtain the display " **GB OK** ".

In Manual Mode, adjust it from 00 to 30 with . Exit with

Note : To improve stability on wet beach (salt water):

Reduce Audio Response (0-1) / Increase Reactivity (4)
Power: Level 1 maximum. / Sensitivity: (70-85).

Note : In wet zones (salt water), it is important to sweep while keeping the coil parallel to the ground, yet not touching it.

Note : In wet zones select the Wet Beach factory programme.

Note : If you see the G.B FAIL screen. It is possible that the soil is irregular or not mineralised. Adjust the ground balance from 25 manually.

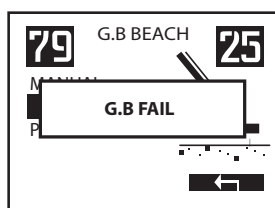
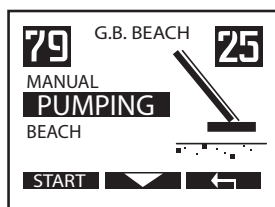

The non - motion mode allows the user to operate the coil motionless above a target. It is useful to locate metal targets inside houses, cellars; also it is widely used to follow underground metal pipes.

MODE : allow to choose between 4 modes :

- 1-Pinpoint:** to locate metal targets
- 2-Non-motion Audio Disc:** audio tone upwards for good targets and down for ferrous. Application: general use, mineralised ground
- 3-Non-motion All Metal :** All Metal + will also detect anomalies in ground minerals plus some ceramics
- 4-Non-motion Disc :** discrimination with single tone. Application: search inside walls.

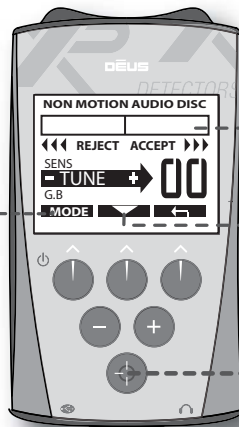

- Meter Accept/Reject
- Press arrow to scroll through the functions:
 - **TUNE :** allows to calibrate threshold to the ground.
 - **SENS :** adjust the depth.
 - **GROUND :** adjust the ground balance.
 - **DISCRI:** adjust the rejection of undesirable targets.
- Used to access the **NON-MOTION** mode and/or to update the threshold(re-TUNE).

PINPOINT (localisation)

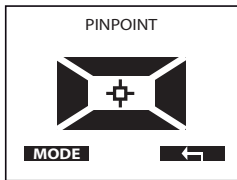

Position the coil barely off the ground (2 to 5 cm/ 1 to 2 inches) and to the side of the target. Press to calibrate the threshold.

Move the coil slowly across the target. The loudest sound and highest audio pitch indicates the target position.

To narrow the field of detection and to improve the target location: Position the coil, close to the target but not on the center. Press to re-tune the threshold then locate the target as step 2.

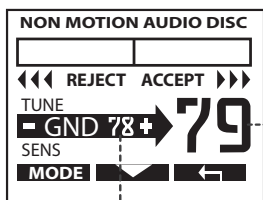

"Ground value" Adjust value manually

NON MOTION DISC – NON MOTION AUDIO DISC & ALL METAL

Non-motion Audio Disc and **Non-motion All Metal** both require fine ground balance adjustments in order to keep a stable operation.

- 1** Pump the coil, and enter the observed "ground value" with
- 2** Position the coil barely off the ground (2 to 5 cm/ 1 to 2 inches). Set the Sensitivity to stabilize the detector during sweeping. Then adjust the Tune to obtain an audio threshold barely audible.

NON-MOTION DISC requires no ground balance adjustment, it is useful to locate metal targets inside walls, and gives a good distinction between ferrous and non-ferrous. Set this mode, as indicated in step 2.

Regularly, press to re-Tune the threshold (coil barely off the ground 2 to 5 cm/ 1 to 2 inches). How frequently you recalibrate will be linked to ground variations or temperature.

Note : On Wet Beach, select program 7 before using the Non Motion Mode and use **Non-Motion Audio Disc** mode with **G.B.** at 15/27.

PINPOINTER MI-6

When connected the MI-6 pinpointer transmits its audio signal directly to the DEUS, a new menu will now be available with extended functions.



Pairing the remote control with Pinpointer

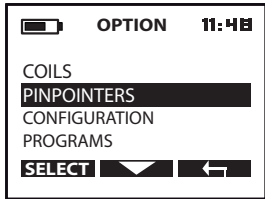

- 1 Choose **OPTION**
- 2 Press and select **PINPOINTERS**
- 3 Select **PAIRING**

Turn on the MI-6 , then hold the button down for 8 seconds

- 4 Once paired the MI-6 will operate with the DEUS.

Note : When pairing, the MI-6 automatically switches to program 7 (DEUS). This program will only work with the DEUS. Program 7 will not generate any sound or vibration.

Note : You can paire your MI-6 only with the XP wireless headphone (pg 27)

Remove the MI-6 from the Menu

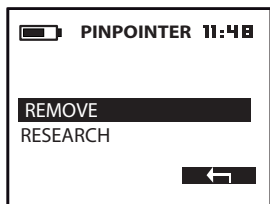

Choose **REMOVE** and press YES.

Note : To use the MI-6 without the DEUS, select programs 1 to 6 on the MI-6 menu. To change program: Switch MI-6 on - press the button for 5 seconds, a melody indicates that you have entered the program selection mode, press to correspond with the desired program number (eg press 2 times for program 2). After 2 seconds the melody indicates the MI-6 has returned to the search mode.

Recover a lost MI-6

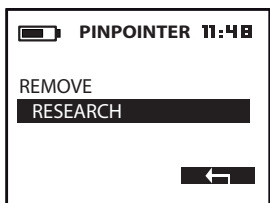

Find your pinpointer within a radius of 25 meters, even if switched off and missing after several weeks.

- 1 Press **RESEARCH**
- 2 The pinpointer will start sounding with a flashing LED.
- 3 Press the pinpointer button and return to the search mode with

MI-6 active display screen

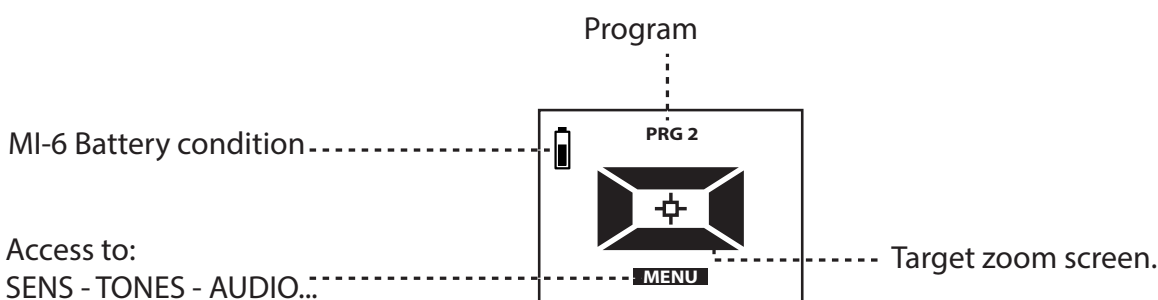

THE MI-6 - EXTENDED FUNCTIONS

Sensitivity

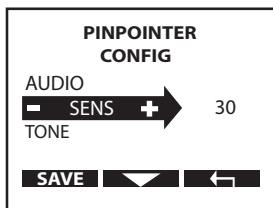

The MI-6 has 50 levels of sensitivity via the remote control.

Press \ominus or \oplus The MI-6 has 50 levels of sensitivity via the remote control.

Note : For precise object location, low sensitivity levels, such as prog 1 and 2, are recommended. The high sensitivity level (prog 3) is for cache location or searching in walls and furniture.

Retune At any time, you can re-calibrate the MI-6 by pressing the button very briefly while away from any metallic source. On mineralized soil, salt water, re-calibrate it in contact with the ground. To localize detection range, re-calibrate (de-tune) near to the object.

Tone

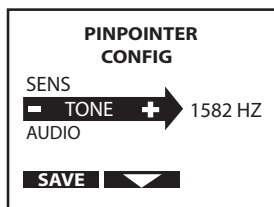

The MI-6 audio PULSE tone can be adjusted from the remote control, tones range from 120 to 1582 Hz. (Audio PULSE mode only)

Press \ominus or \oplus to adjust the tone.

Note : Tone is available only with the Audio PULSE mode

Audio PITCH / Audio PULSE

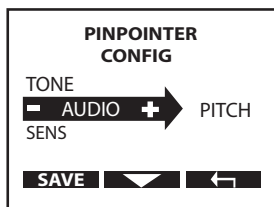

- **Audio PITCH:** The sound varies in tone and intensity, it is the default mode, it offers fast target location.

- **Audio PULSE:** Has a higher sound, intended for noisy environments. Target location is not as precise as PITCH mode. Pitch and Pulse mode both have the same performance.

Press \ominus or \oplus to switch from one mode to another.

Making and saving a custom program

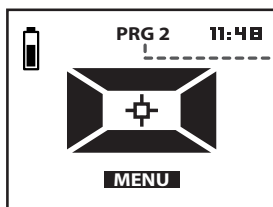

Choose from one of the 3 factory pre-set programs in the menu to make your own custom program which can then be saved as (prg4).

1 Select the program you want by pressing \ominus or \oplus

2 Enter the settings by pressing **MENU**

3 Save your settings by pressing **SAVE**

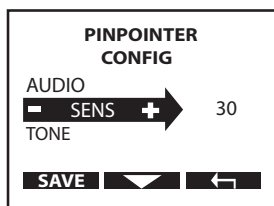

Note : When first used the MI-6 will start on program 2. After this it will start on the last used program.

Note : The 4 programs on the remote control are separate from the programs inside the pinpointer. When used independently the MI-6 (unpaired) will always use it's factory programs.

REMOTE CONTROL'S PROGRAMS

From 10 programs factory (P1 to P10) , you can modify them and create 8 additional user programs. (P11 to P18).

- 1 Press **OPTION**
- 2 Choose **PROGRAMS** with then press **SELECT**

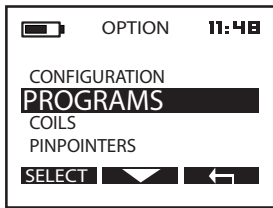

Save a modified program (11 to 18)

- 1 Choose **SAVE** . Press on **SELECT**
- 2 Select an unused slot (11-,...) with then press **SELECT**
- 3 Edit the name and press **VALID** , your program is saved

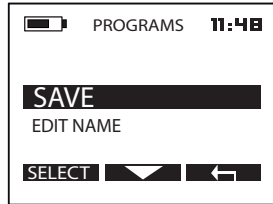

Modify the name of a program (11 to 18)

- 1 Choose **SAVE** stop on the program you wish to modify then press **SELECT**
- 2 Replace "name program" press **YES**
- 3 Scroll through the characters

And to advance to the next data entry zone. Or to delete the previous character. Press **VALID**

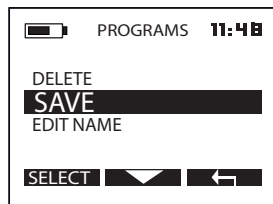

Delete a modified program (11 to 18)

- 1 Choose the program to delete in main menu with
- 2 Press **OPTION** then select **PROGRAMS** .
- 3 Select **DELETE** and press **YES** , the program is deleted.

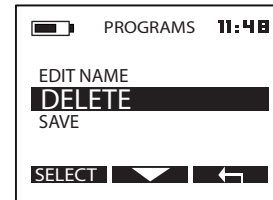

COILS

When first purchased, the Dēus is only configured to operate with its original coil. If you have one or more optional coils which have already been paired (see below), you can select which one you want to use from the menu list.

- 1 Press **OPTION**
- 2 Choose **COILS** with then press **SELECT**
- 3 Switch on the headphones close to the remote control.
- 4 On the remote control, press to scroll through the list of available coils and stop on the one you wish to activate. This coil automatically becomes active within 4 seconds, while the previous coil reverts to standby mode.
- 5 Press X2 to return to the main menu.

Note : If you switch on the headphones after changing the coil via the remote control, the headphones will not automatically register this change. You will therefore need to change the coil manually via the headphones. (pg 25)

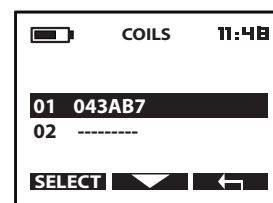
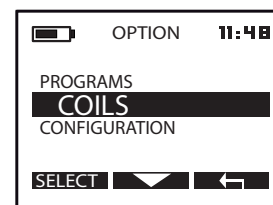

Example

Pairing the remote control and the headphones with a new coil

If you purchase an additional coil, it will need to be paired with the remote control and the headphones. You can then switch between coils with a simple click via the remote control. To pair a new coil enter its serial number into the remote control and headphones. The serial number is printed on the coil and is sometimes found on the invoice as well.

- Before you pair a new coil, turn on the headphones and remote control.
- Check that they both work correctly with your original coil.
- Keep the headphones, remote control and also the new coil close to each other and follow the following steps:

Entering the serial number

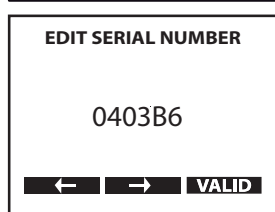
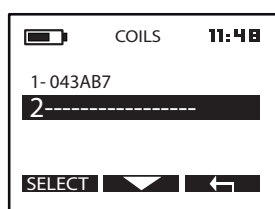

- 1 Press **OPTION**
- 2 Choose **COILS** with then press **SELECT**
- 3 Select an unused slot (-----) with then press **SELECT**
- 4 At the point where the cursor is flashing, scroll through the characters using to make your choice.
- 5 At the sixth digit press **VALID** then X2 to return to the main menu.

The remote control now adds this new coil to its list, then transfers the updated list to the headphones.

If the headphones do not recognise this coil, for example because they were switched off while the serial number was being entered in the remote control, You then have 2 options to pair it:
 1: Turn on the headphones and the remote control with the previous coil (for example the original one). The list of coils from the remote control will be sent automatically to the headphones.
 2: Enter this new coil's serial number manually in the headphones as well (pg 26).

A coil's serial number is unique. The headphones or remote control cannot function with a coil if the number entered does not correspond to the actual serial number printed on the coil.

Delete coil from the list

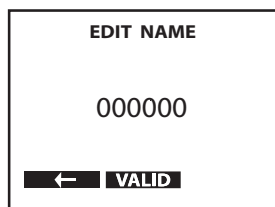
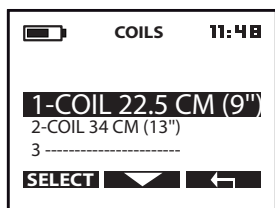

- 1 Choose the coil and press **SELECT**
- 2 Select **EDIT SERIAL NUMBER** and press **SELECT**
- 3 Delete all characters with Choose "space" (the previous character 0)
- 4 Press **VALID** the coil is deleted.
- 5 **DELETE CONFIRM** select **YES**
- 6 Press x 2 to return to the main menu.

CONFIGURATION

This allows you to modify the remote control's general technical settings.

Press **OPTION** Choose **CONFIGURATION** with **▼** then press **SELECT**

Loudspeaker

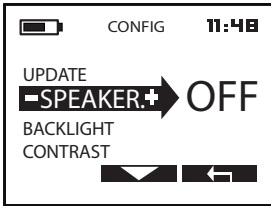

Enables the remote control's loudspeaker to be activated or not.

Duration of backlighting

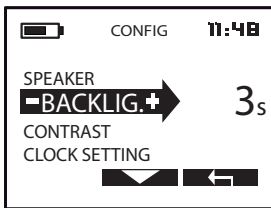

The remote control screen has a backlighting function which switch on as soon as any button is pressed and goes off automatically after a certain length of time. You can define this time in seconds:

OFF - 3s - 10s - 60s - 120s - ON (permanent)

Note : You can leave the backlighting on permanently (ON) as this function uses very little power and only affects the remote control's battery life by about 10%.

Contrast

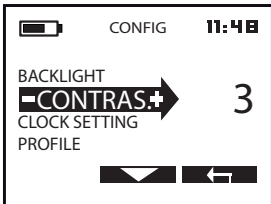

To improve readability in all lighting conditions you can adjust the contrast of the display.

Clock

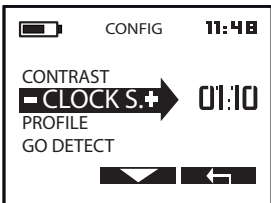

This changes the clock setting that is displayed on the main menu.

Profile

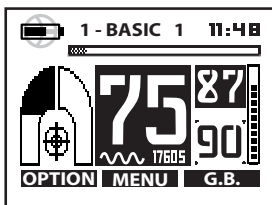
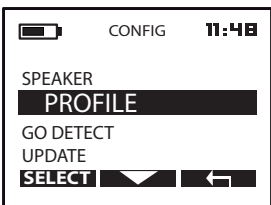

This option enables you to customise the main screen.

You have several profile choices:

- CURVE:

Representative curve for the detector's active settings relating to Sensitivity.



Fast



Slow and Deep

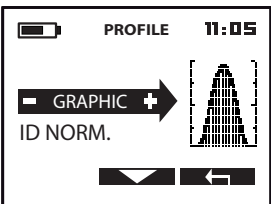

- IRON HORSE SHOE

Ferrous/Non-Ferrous target strength (or depth indicator), at the left strength of the ferrous, at the right strength of the non-ferrous.

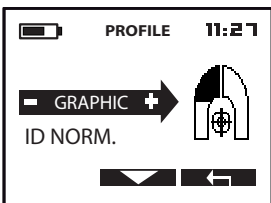

Profile continued...

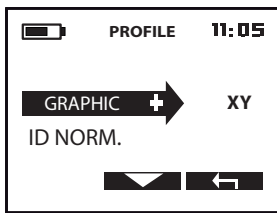

OSCILLOSCOPE DISPLAY XY: The target signature is displayed as an oscilloscope. The XY screen provides a visual assistance and may improve the identification of difficult targets.

For example: The identification of targets that do not have a precise signature (some ferrous, cans ...). The XY profile can be selected as the default display. The display magnification of the XY trace has 10 levels of adjustment using the Zoom function.

Alternating display
Between target reading
and battery level.
Display Area for
Ferrous targets

Display Area for
Non-ferrous targets

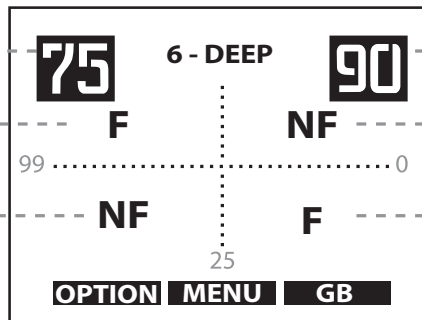

Ground phase reading

Display Area for
Non-ferrous targets

Display Area for
Ferrous targets

XY screen target examples :

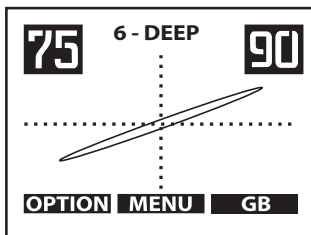

Typical non ferrous
Signature for coins.

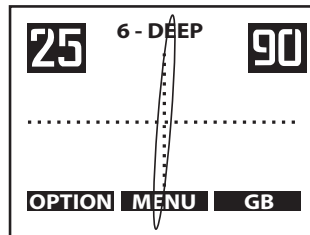

Typical non ferrous
signature for foil.

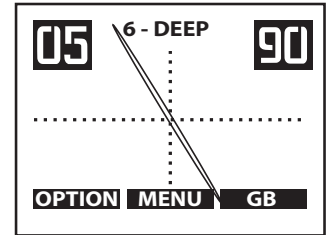

Typical signature for
rejected ferrous.

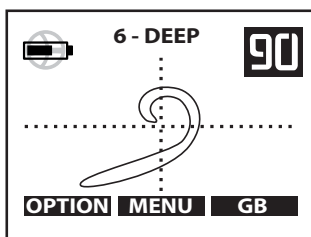

Typical signature for cans and difficult to reject large ferrous items.

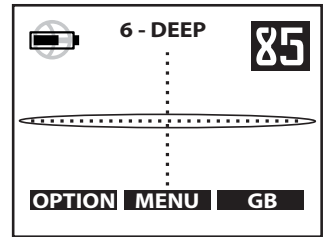
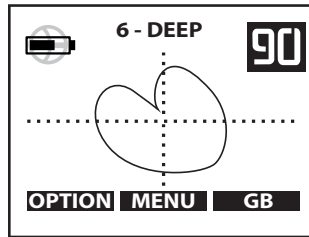

Typical signature from
ferrite and ceramics.

Zoom XY mode

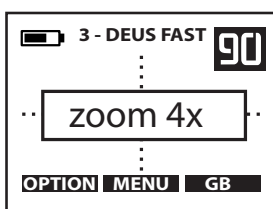

- 1 Press the Pinpoint button for 2 seconds to display the zoom function.
- 2 Adjust the zoom by pressing the \ominus or \oplus key

ID norm

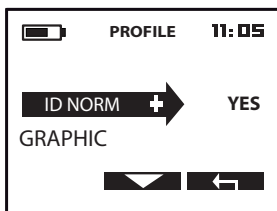

ID NORM (Standardization of the target ID) Allows the target value range to indicate the same for all the frequencies. Based on the 18Khz setting.

Note : This function is not available with the HF coils.

Smartphone application

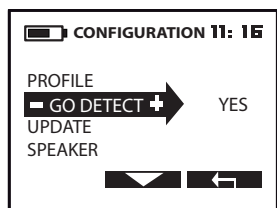

YES : Target and ground data can now be sent via link to a smartphone.

No : Feature disabled

This new application will soon be available for the Deus, features include : Mapping of detected signals, view / save your search tracks, log finds plus much more, all accessed from and your smartphone (soon available on the web).

Updates

The software can be updated via the Dēus USB interface and an internet connection. Full information is available on our website:

www.xpmetaldetectors.com

DETECTORS > DEUS > DEUS UPDATE



Use the single USB cable.



WS4 and WS5 have the same functions

Indicates the battery charge level of the coil and the headphones (alternates every 4 seconds)

Displayed : Coil battery level-----
Not displayed : Headphones battery level---

Indicates the setting value or the number of the factory program P1, P2, etc

Indicates that the radio link with the coil is active

Control pads
 Increase / decrease values

To switch ON : Press

To switch OFF : Press simultaneously

and

Used to scroll through the detection menus and their setting values:

- DISC ----- Discrimination
- SENS ----- Sensitivity
- GND ----- Ground
- FREQ ----- Frequency
- tone ----- Number of Tones
- VOL ----- Audio volume
- COIL ----- Selected coil or MI-6
- P1 to P10 ----- Factory programs

USB/mini-B charging connection

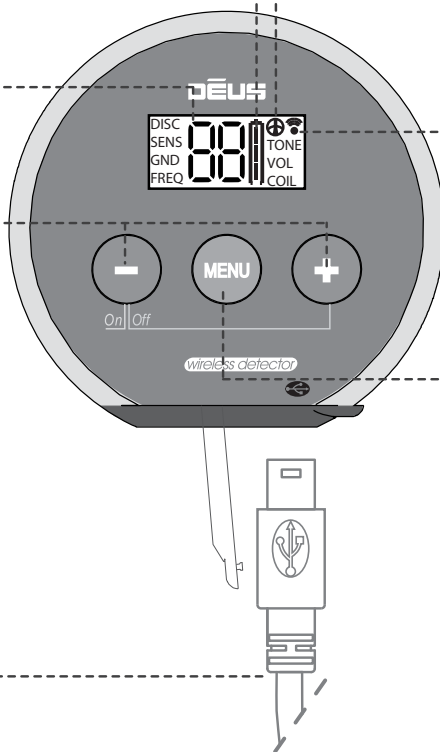

MENU

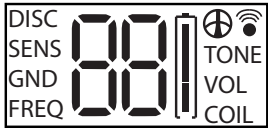

Menus accessed via the headphones have the same range of settings as the remote control.

Remote control ON: Only the volume control can be adjusted.

Remote control OFF: All settings can be adjusted.

Press to access the different menus

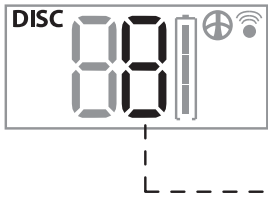

DISC Discrimination: 0-99 (pg 08).

Adjust with

-----A flashing digit represents a digit after the decimal point.



SENS Sensitivity: 0-99 (pg 09).

Adjust with



GND Ground balance (pg 12).

60-95: (inland ground)

0-30: (Only with program N°7, for beach, wet zone)

Adjust with



FREQ Choice of frequency used (pg 09).

Change with



TONE Choice of number of tones: 2, 3, 4, 5 tones, Full tones, P! (PITCH) (pg 31).

Change with



VOL Adjusts sound volume in headphones: 0-9.

Adjust with

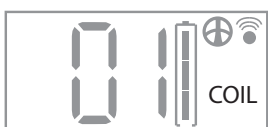

COIL Choice of coil used when several are available.

The coils are numbered according to the order in which they were entered:

01 = Original coil

02= Coil 2

PP = Pinpointer (pg 17-18)

COIL

COIL If you are detecting with the remote control and you use it to change to a new coil, the headphones will automatically register this change (if they are switched on). Otherwise it can be done manually with this menu. Always leave the headphones switched on when you are changing the coil via the remote control, otherwise they will not register the change and will remain connected to the previous coil. If this should occur, use the remote control to return to the previous coil (with the headphones switched on) and switch to the new coil again to re-register it with the headphones.

 Remember that before you can use a new coil for the first time, you need to enter its serial number into the headphones and remote control (pg 24/30).



Pairing the Headphones with a new Coil

When delivered, the headphones and remote control have already been paired with the original coil, so no action is required on your part. However, if you purchase an additional coil, before using it for the first time you need to pair it with the remote control and the headphones, to enable it to recognise and communicate with them. You can then change coils with a simple click using the remote control (pg 19) or your headphones (pg 26).

If you leave the headphones switched on when you pair the remote control with a new coil, they are also paired with this new coil, which is then added automatically to the list in the headphones menu



If you do not have the remote control, or in the event of a problem, you can manually pair the headphones with a new coil. To do this you need the serial number of the coil to be paired:



- 1 Press  until you reach COIL
- 2 Choose the flashing free slot with   for example 02 (01 is already assigned to the original coil).

If this coil has already been paired with the remote control, ensure you choose the same slot number in the headphones.

- 3 Press  for 5 seconds to switch to serial number entry mode.

- 4 With   enter the first digit of the serial number then validate it with .

Continue in this way until you reach the sixth digit.





The new coil is now operational in this slot and should become active.



A coil's serial number is unique. The Dèus cannot use a coil if the number entered does not correspond to the actual serial number printed on the coil (and sometimes appearing on the invoice as well).

Delete coil



Press  until you reach COIL, then for 5 seconds press . Choose the flashing coil to delete with  , and press  to validate.

Programs P1 to P10

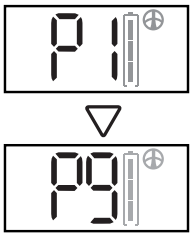

Choose one of the 10 pre-configured factory programs.

- 1 Press until you reach P1/10 screen.
- 2 Scroll with and choose the program number.

Note : Programs are identical to those in the remote control and are numbered in the same way from 1 to 10. e.g. P3 headphone = factory program 3 in the remote control. Each time the remote control is switched on next to its accompanying headphones, all the remote control's settings are loaded into the headphones, which are then stored in the memory even when switched off.

Save a modified program (P11 to P18)

Save a program after changing a few settings:

Press until you reach PROGRAMS (P1,...), then for 5 seconds press . Choose the flashing free slot with (from P11 to P18), finally save your programs by pressing .

Delete a modified program (P11 to P18)

Press until you reach PROGRAMS (P1,...), then for 5 seconds press . Choose the flashing program to delete with , and press to validate.

Replacement of the backphone



The electronics housing of the wireless headphones contains all the electronics and the lithium battery, it represents your headphone's brain! (ref: D091) Fitted on a sliding support, it has the advantage of being able to disconnect from the backphone with a single click. This backphone is an inexpensive spare part that can easily be replaced by yourself (ref: D096). Available from all our resellers.

Pairing the headphones at the MI-6



- 1 Press until you reach **COIL**.
- 2 Press to reach **PP**, then press 3 seconds. **PP** flashing.
- 3 Turn on the MI-6, then hold the button down for 8 seconds. PP is paired.
- 4 Press

Remove the MI-6 at the headphones

- 1 Press until you reach **COIL**.
- 2 Press to reach **PP**, then press 3 seconds; **PP** flashing.
- 3 Press

BATTERY STATUS

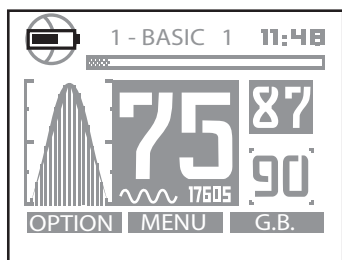

The remote control alternately displays :

The symbol  which indicates the coil's charge level.

The symbol  which indicates its own charge level.

If you only use the headphones without the remote control, you will also need to know the coil's charge level.



 **Displayed** = coil's charge level.
Not displayed = headphone's charge level.

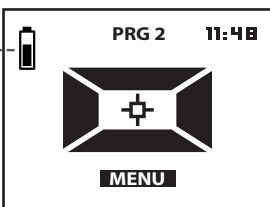
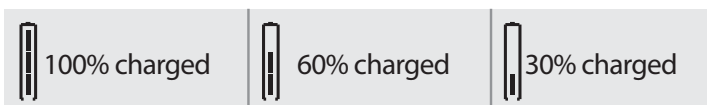
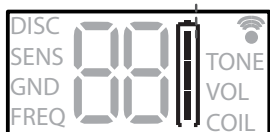

When the pinpointer is switch ON and paired with the remote control,

The symbol  which indicates the MI-6's charge level.

BATTERY LIFE

HEADPHONES: 22 hours / **REMOTE CONTROL:** 19 hours / **COIL** : ± 15 hours

The search coil's battery life may vary depending on the modes used. The table below shows battery life according to frequency and power selected

DEUS COIL	Power at 1	Power at 2	Power at 3	HF COIL	Battery life
Frequency 4 kHz			11 hours (Fixed power)	Frequency 14 kHz	20 hours
Frequency 8 kHz	19 hours	13 hours	11 hours	Frequency 30 kHz	27 hours
Frequency 12 kHz	19 hours	13 hours	11 hours	Frequency 55 kHz	28 hours
Frequency 18 kHz	20 hours	14 hours	11 hours	Frequency 80 kHz	28 hours

May vary depending on the age of the battery.

Note : The Deus is regulated in such a way that avoids any deterioration in performance even when the battery level is low !

CHARGING TIME

COIL: 2h30 / **REMOTE CONTROL** and **HEADPHONES:** 3h00.

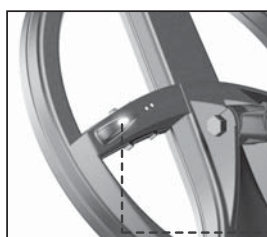

LiPo batteries (Lithium polymer) do not suffer from the 'memory effect' so you can recharge them at any time without first having to wait for them to fully discharge.

The LED on the coil is on continually when charging is underway.

When charging is complete, the LED reverts to flashing intermittently.

(3 seconds ON, 3seconds OFF)

Note : The charging time varies depending of the battery condition, the HF COIL battery has more capacity, it will require a longer charge time.

CHARGE

The search coil, remote control and headphones are all powered by lithium polymer batteries. These miniature, high-capacity batteries can be recharged quickly. The different Dēus elements can be charged while switched on or off, but switching them off speeds up the process. You should use the power adaptor supplied, which enables all three elements to be charged simultaneously when used with the USB/3 mini-B cable, also supplied.

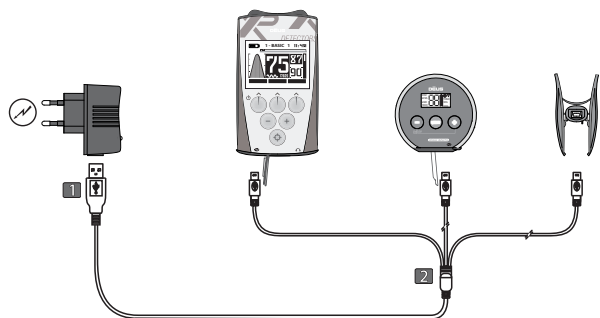

- 1 Connect the **USB plug** to the power adaptor
- 2 Connect the **mini-B plugs** to the remote control, headphones and to the charging clamp.

The search coil is charged via the connection clamp supplied, which is connected to the coil according to the grooves in the coil cover. You will see that the clamp is shaped in such a way to prevent it being connected the wrong way round.

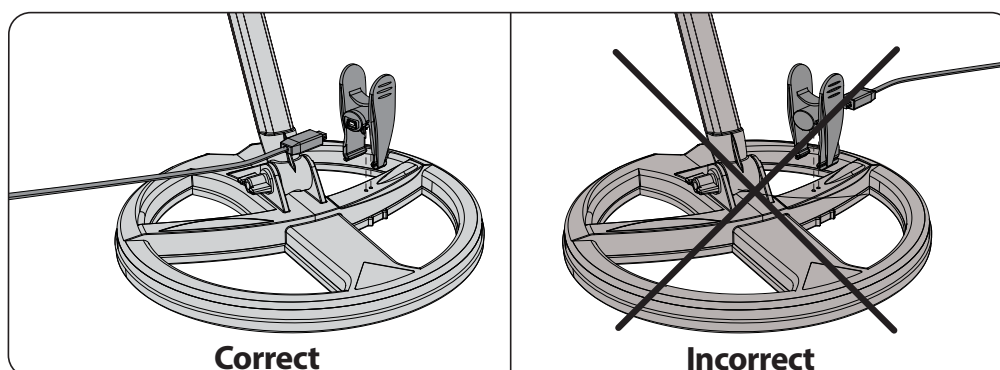

Ensure that the clamp is the right way round before connecting it to the coil Do not adjust after fitting

LITHIUM POLYMER (LIPO) BATTERY DURABILITY

The LiPo batteries are designed to bear hundreds of charges and to last several years in your detector, thus resulting in significant savings in terms of purchase of batteries. After 300 to 400 charging cycles the battery still has 80% of its capacity, which then gradually begins to decrease over subsequent cycles. As an indication, the batteries should last for around 3 to 4 years when used on a weekly basis.

REPLACING BATTERIES

The three Dēus batteries are identical.

The batteries for the wireless headphones and the remote control are easy to replace as they are connected to the circuit with a mini-connector and double-sided adhesive tape. The search coil battery is sealed for obvious reasons - safety and impermeability. It must be returned to our service department or an **XP** distributor for replacement.

How to replace the coil battery:

www.xpmetaldetectors.com

VIDEO XP > DEUS > 05 - DEUS BATTERY KIT

The HF coil's battery is inside the lower stem, please find the assembly page 4

The batteries are guaranteed 2 years parts and labour.

PRECAUTIONS RELATING TO USE OF THE POWER ADAPTOR AND BATTERY

Acceptable ambient temperature during charging: **0° to 35°C Maximum**

Recommended storage temperature: **25°C**

Batteries



- The batteries are fitted with internal protection systems which shields them from extreme overloads and discharges. They must not be dismantled or short-circuited, which is dangerous and could destroy the protection systems or cause the batteries to ignite.
- Do not leave batteries charging unnecessarily and disconnect the power adaptor when the charge cycle is complete or after 3hrs.
- If you notice any perforation, odour or other anomaly, please return the battery to the seller in a sealed plastic bag and don't try to charge again.



- Never dispose of lithium batteries with your household waste: return them to your XP seller or take them to a designated collection point.
- Do not place the batteries near heat sources and never throw them onto a fire. Never perforate the battery cover or try and weld/solder the battery.
- Do not short-circuit the battery terminals.



- Risk of explosion if battery is incorrectly replaced. Replacing the battery with another of the incorrect type can lead to an explosion risk. Only use LiPo batteries supplied by **XP (ref : D088)**.

Power adaptor



- The power adaptor is only designed for indoor use and should not be exposed to water or humidity.
- Always connect your power adaptor in an accessible, visible place to ensure that it can be unplugged quickly in the event of overheating or other problems.
- Use the special XP chargers in the recommended charging method to charge the battery, do not use other charger, that will cause the battery internal short-circuit and make it heat, smoke or burn.



- Do not charge the devices during a thunderstorm and unplug the power adaptor from the supply.
- Do not charge close to inflammable parts.

Xplorer shall not be held liable for any consequences arising from a failure to comply with the precautions for use.

This section covers the advanced settings. You should ensure that you have studied all the basic parameters before moving on to this section.

MULTI TONES

2 TONES - 3 TONES - 4 TONES - 5 TONES

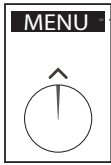

1 Press **MENU**

2 Choose DISC with

3 Press **EXPERT**

4 Choose 2 Tones - 3 Tones - 4 Tones - 5 Tones using

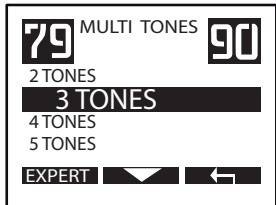

You can use the Multi-tones menu to sort targets into categories according to their conductivity, by assigning a specific audio tone to each category. The higher the target's conductivity, the higher the pitch of the tone. Take some time to become familiar with the 2 Tones, 3 Tones, 4 Tones, 5 Tones modes using different targets, such as an iron nail and some aluminium foil, different coins, etc. The lowest pitched tone is assigned to iron. If you do not wish to hear it, select "Iron Volume" from the menu and reduce its volume to 0.

Note : If you are in 2 Tones mode (low/medium tone) and you reduce the iron level (low-pitched tone) to 0, you then find yourself in 1 tone mode (medium), which is why there is no 1 tone mode in this scrolling menu.

PITCH

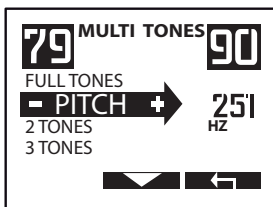

Pitch mode is completely different from the others. It does not take into account the target's conductivity: the strength of the signal generates an audio signal that varies both in volume and height (the audio frequency). This means that a more distant target will generate a low-pitched, weak sound whereas a closer target will generate a high-pitched, strong sound. Pitch mode gives a dynamic signal. It also makes the detector appear more reactive. However, it does not fundamentally affect reactivity, just the audio.

The range of setting can be changed with or from 150 to 603 Hz.

FULL TONES

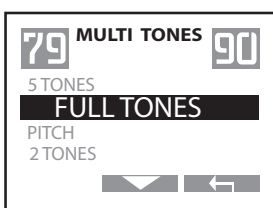

The FULL TONE mode will produce a slightly different tone for each target ID value based on a sliding scale. The higher the target's conductivity, the higher the tone will be. Iron typically will produce a low tone, while silver produces a high tone. See the figure on page 9 to see where specific types of targets fall in terms of conductivity.

MULTI TONES, Thresholds and Tones

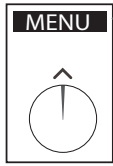

1 Press **MENU**

2 Scroll with and select **DISC**

3 Press **EXPERT**

4 Choose 2 tones - 3 tones - 4 tones - 5 tones with

5 Once you have selected the number of tones (for example: 4 tones) Press **EXPERT**

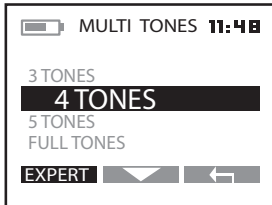

You have the option of customising the sound partitioning of the discrimination range.

A sound frequency (comparatively low or high-pitched) is assigned to each part of the discrimination range. In this example, a low-pitched sound (202 Hz) is assigned to the signals from 0 to 10, a higher-pitched sound (518 Hz) is assigned to the part from 10 to 60, then 644 Hz is assigned to 60 to 87 and lastly a very high-pitched sound (725Hz) is assigned to the part from 87 to 99.

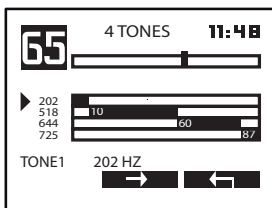

6 Press in order to move the cursor (black triangle) from one setting zone to another.

Note that the cursor first moves up and down to indicate the sound **frequencies** used, then from left to right to indicate each **threshold**.

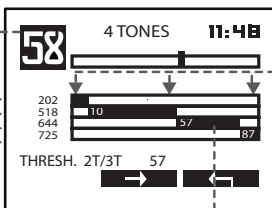

7 Adjust the sound frequencies and thresholds with

Example: If a coin type, which your device registers as 58 on the conductivity index, signals as "medium low" (518 Hz) and you wish it to be signalled as "medium high" (644 Hz), you simply lower the threshold from **60 to 57** or less.

Now, all coins with this conductivity value will register at 644 Hz.

Note : The black bar showing the index of the target is displayed in the top left of the screen (black bar) for help. This enables you to directly adjust the sound responses for targets you select as references.

THRESH 1T / 2T
=
DISC.

Note : The threshold 1 separating the low-pitched tone (tone 1) from the medium tone (tone 2) is the same as the Discrimination value. These are the same settings.

TX POWER

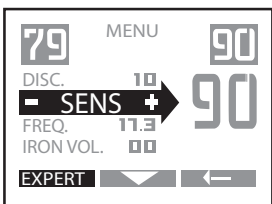

1 Press **MENU**

2 Scroll with and select **SENS**

3 Press **EXPERT**

The Dēus enables you to adjust the strength of the emitted electromagnetic field according to three levels (from 1 to 3).

4 It is adjusted using

5 Press x 2 to return to the main menu.

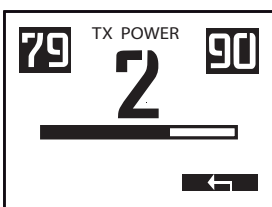

By default the power is set to level 2, which offers a very dependable performance level that is largely sufficient in most cases. The power only has a subtle effect on the device's pure performance with regard to sensitivity. However, it increases your detector's power consumption as well as alter its stability on difficult ground. On iron-infested, mineralised ground, there is no need to use a high power setting, level 1 will be sufficient as in any case it is impossible to detect deeply in this kind of ground. It is therefore better to limit the saturation caused by iron and the ground by lowering the setting. In this way you will improve analysis and will ultimately find as many, if not more, targets since you will be better able to hear them.

Note : Power is set to maximum for the 4 kHz frequency. You do not have access to the Expert menu when you are on this frequency. The HF coil also has a fixed TX Power.

AUDIO OVERLOAD

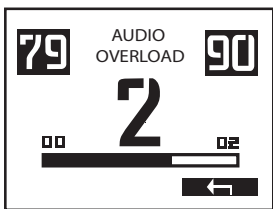

- 1 Press **MENU**
- 2 Scroll through the menu to reach the **AUDIO RESPONSE**
- 3 Press **EXPERT**
- 4 Adjust **AUDIO OVERLOAD** with
- 5 Press x2 to exit.

Allow the user to choose an overload sound when a target is close to the coil.

FREQUENCY SHIFT

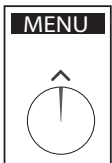

- 1 Press **MENU**
- 2 Scroll with and select **FREQ**
- 3 Press **EXPERT**
- 4 Adjust the frequency with
- 5 Press x2 to return to the main menu.

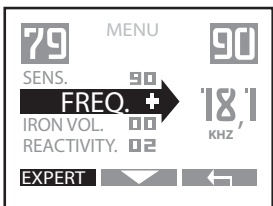

Starting from the central frequency:

- 2 other frequencies are available, with the standard DEUS coils.
- 6 other frequencies are available, with the DEUS HF coils.

You can shift your operational frequency slightly to avoid occasional interference, particularly that generated by another detector nearby.

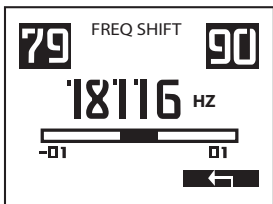

Note : Wherever possible, remain on the central frequency, which is more closely attuned to the emitter coil. During a rally or other group event, if you suffer from any interference do not hesitate to shift the frequency. You can also simply change the basic frequency (4, 8, 12, 18kHz).

Note : When you choose a FREQ SHIFT, from the central pre-set the TX POWER is fixed to level 3 (TX 3) (Standard DEUS coil)

Note : 4kHz frequency is fixed and cannot be shifted.

SILENCER

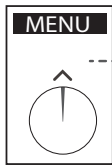

1 Press **MENU**

2 Scroll with and select **REACTIVITY**

3 Press **EXPERT**

4 Adjust the Silencer with

5 Press x2 to return to the main menu.

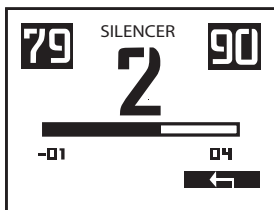
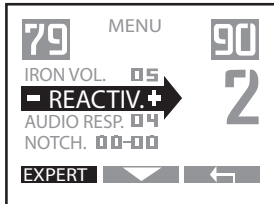

A few large iron objects or unusual shapes are often more difficult to discriminate. Often iron objects generate a few audible remnants of broken, or inconsistent signals (crackling). When you increase the silencer you are applying a filter which eliminates the crackling caused by ferrous. Level 2 represents a good compromise, but if you have difficulty identifying bottle caps, use level 4.

Note : The Reactivity menu takes precedence over the silencer, so if you change the reactivity value this automatically imposes an appropriate silencer value. This is designed to avoid the silencer being set to a value that could reduce the effectiveness of the reactivity setting.

MULTI NOTCH AND WINDOW WIDTH

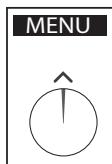

1 Press **MENU**

2 Scroll with and select **NOTCH**

3 Press **EXPERT** and go to NOTCH screen.

4 This advanced notch function enables you to widen the rejection window in the event that the undesirable target(s) have a wider conductivity range than the standard 6-point window.

For example, if the undesirable target is generating a ID ranging from 28 to 46, you can use this option to lower the value of Threshold 1 to 28 and increase Threshold 2 to 46.

5 Select threshold 1 or 2 with

6 Adjust the values with

7 Press X2 to return to the main menu.

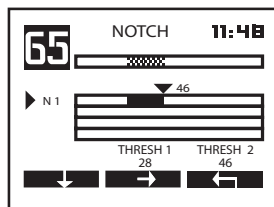

If several targets with different conductivity levels are a problem, you can activate two other notches: N2 and N3

Use to select N2 or N3, and adjust as for N1.

To exit use

Note : You will note that the notched zones are greyed out in the conductivity bar on the main page.

NOTCH GROUND

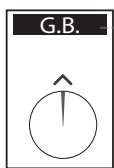

The Ground Notch complements the ground balance settings : it enables a "window" of ground value to be rejected rather than rejecting all the ground values below the setting. You can for example adjust the ground balance on the value of the prospected ground (eg: 78), then reject the false signals due to hot-rocks by adjusting the NOTCH GROUND between 83-90 only, thus you will not reject the ground value from 78 to 83.

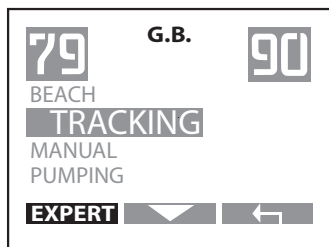

- 1 Press **G.B.**
- 2 Press **EXPERT** and go to NOTCH GROUND (only in MANUAL/ TRACKING).

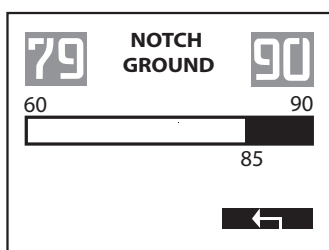

- 3 Adjust the NOTCH GROUND with

- 4 Exit with

Note : To search for meteorites, the majority of which have values from 84 to 89, disable the NOTCH GROUND, so as to detect them.

PRACTICAL INFORMATION

ADVICE BEFORE BEGINNING DETECTING

Metal detecting is a fascinating leisure activity that can bring you a lot of satisfaction. However, it requires a minimum of learning in order to get the most enjoyment.

Begin by familiarising yourself with your equipment and its operation on a suitable practice ground.

To do this, we recommend that you take an assortment of different objects: coins, everyday items, metal rubbish, etc. Then find a patch of ground relatively free from metal pollution and far away from any electromagnetic interference (high voltage power lines, electric fences, domestic appliances, etc.). For instance your garden would probably be one of the most unsuitable places to begin as there is too much domestic waste in the vicinity.

To ensure that the site is suitable for practising, swing the coil over the ground as if detecting. If you hear a multitude of sounds then move to another place.

Once you have found a suitable spot, arrange your objects on the ground, spacing them approximately two coil widths apart. Before placing an object, use the device to check that there is no metal already in the ground.

Then, take some time to observe your device's reactions when it passes over each target. You can then sort them according to the sound response type and try and understand what makes them similar or different. If you feel comfortable with this exercise, you can also try out some of the pre-configured settings.

OPTIMISE YOUR SEARCHING

When detecting, it is important that you sweep the coil parallel to the ground, using wide movements, as close as possible to the surface (without actually touching it). Proximity to the ground will increase the likelihood of detecting a deep target and will enable the most discreet objects to be identified more easily. You are advised to avoid knocking the coil, as although it is designed to tolerate this kind of stress, careful treatment will prolong the life of the device and guarantee you better perception of targets.

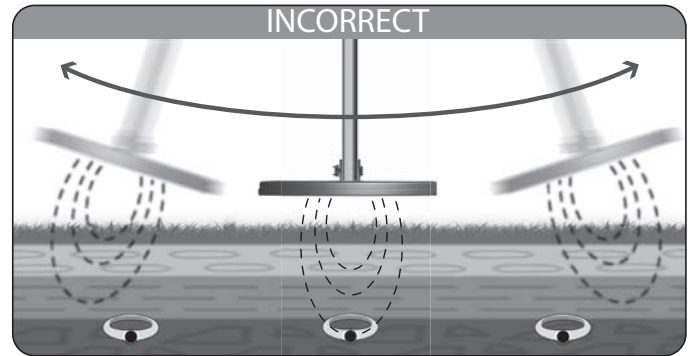
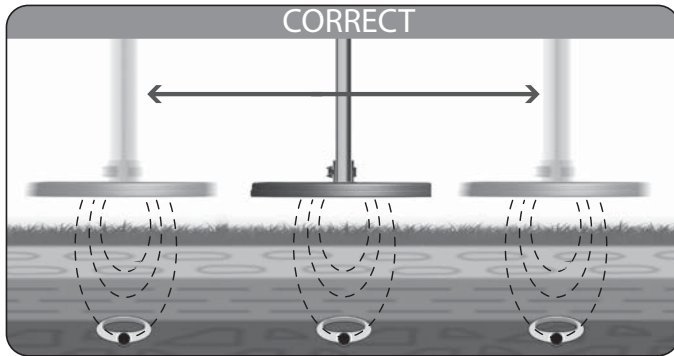

When you are detecting, you are free to choose the rate at which you move.

For example, if you prefer to cover a zone at high speed while detecting, this will certainly give you a global 'snapshot' of the site. However, it is clear that this way of detecting will also leave large areas of ground unexplored between each sweep. On the other hand, if you insist on closely scrutinising every inch of the ground, you should ensure that each sweep slightly overlaps the previous one, in order to reduce to a minimum the area that your coil has not scanned.

You should also bear in mind that you will further increase your chances of finding and identifying a target by sweeping more slowly. This particularly applies in metal-infested ground (when there are more targets to be sorted) or when you are searching for deeper targets.

LOCATING A TARGET USING CROSSED SWEEPS IN MOTION MODE

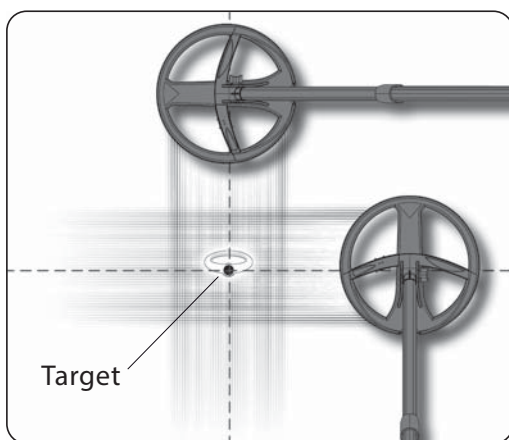

Once the detector has indicated the approximate presence of a target in Motion mode, if you are having difficulty locating the target then sweep the place where you heard the sound. Slowly reduce the amplitude of your movements and make a mental note of the spot where the sound is loudest. If necessary, indicate it with a mark on the ground. Then move a quarter turn around the spot and begin sweeping again in the same way (at 90° to the first sweep). You should then locate the precise zone containing your target at the intersection of the two sweeps, where the sound is loudest. Continue with crossed sweeps over the target. The loudest and highest pitched audio signal indicates the centre of the coil and therefore the position of the target.

Dēus is a precision device, designed to be as robust as possible. Despite this, it is important to take care of it and exercise certain precautions in order to prolong its life:



Do not store your device for long periods with discharged batteries. Ideally you should discharge/recharge the batteries at least once a month, and if possible store them 40 to 70% charged.



Do not expose your detector to extreme temperatures, particularly inside a car in full sun.



Do not expose your detector to the sun without reason when it is not being used.



When you switch on the detector ensure that the coil is not near any metal objects.



The remote control of your detector is not waterproof. In wet weather be sure to protect it !



Use the storage case that is supplied with the headphones and never carry them at the bottom of a bag without protection.



Use the case that is supplied with the remote control to protect it in adverse conditions, and when the detector is stored away.



Do not use solvents or alcohol to clean the detector. Soapy water is sufficient.



Depending on how you use your detector, it may be advisable to clean its elements regularly. A damp cloth can be used to clean the non-waterproof parts (headphones and remote control).



After use, remove any dirt from the stem's locking mechanisms.

You become aware of abnormal performance, instability, false signals, interference, for no apparent reason

CAUSES	SOLUTIONS
Sensitivity is too high.	Lower it.
You are in a zone with a lot of interference (high-voltage power lines, electric transformer, electric fence).	Lower the sensitivity change frequency/frequency shift or move to a different zone
There is a storm nearby and the electromagnetic discharges of lightning are interfering with the detector.	Switch off and wait for the storm to pass
You are close to other working metal detectors.	Change or shift the frequency (pg 33). or move further away.
The ground balance is set too low. Reset it	Manual mode
The ground is heavily infested with iron and other metals.	Find a less infested place. Don't practice in your garden!

The coil does not switch on, unlike the remote control and the headphones

CAUSES	SOLUTIONS
You have a different coil selected in the menu : OPTION / COIL ON the remote control or in the menu COIL on the headphones.	Select the corresponding coil (pg 19 and 26).
The serial number of the coil that you had entered in the remote control was incorrect or was changed inadvertently.	Check the coil's serial number (pg 19).paying attention to D & O also B & 8.
The coil battery is discharged	Recharge it.
The coil is defective.	Contact your reseller.

There is no detection sound in the headphones despite them being switched on (and pressing the buttons generates an audible beep)

CAUSES	SOLUTIONS
Check that you do not have a different coil selected in the COIL menu (pg 26). (headphone)	Select the right coil (pg26).
The headphones have not yet been paired with the coil.	Pair them (pg 26).
The coil's serial number was changed inadvertently in the headphones and the headphones are no longer paired with the coil.	Pair them (pg 26).

There is no sound in the headphones when passing over a target and pressing the buttons generates no audible beep

CAUSES	SOLUTIONS
The backphone is faulty.	Change it, it is easy to replace (pg 27).
The earpiece is faulty, for example its keypad was poorly reconnected to the circuit after being removed, or the audio contacts are faulty or dirty.	Contact your reseller

SPECIFICATIONS

Radio	Link	Digital wireless	
	Channels	36 automatic channels	
	Radio frequencies and Radio power	2.4 GHz / 0.56 mW	
	Detection frequency	4 - 8 - 12 - 18 kHz + shifts (Standard DEUS coils)	
		15 - 30 - 50 or 80 kHz + shifts (depending HF coils)	
	Sensitivity	99 levels	
	Transmitter Power	3 levels (Standard DEUS coils)	
	Reactivity	6 levels	
	Sound Curve	8 levels	
	Iron level	6 levels	
Settings	Multi tones	1, 2, 3, 4, 5, Full tones, Pitch,+ Expert	
	Ground balance	Tracking, Pumping, Manual, Wet beach	
	Multi-notch	Yes, with adjustable window width	
	Mode	Motion/None Motion	
	Non motion Pinpoint	Yes, audio and visual	
	Discrimination	audio and visual	
	Iron discrimination range	164 levels	
	Non-iron discrimination range	90 levels	
	Factory programmes	x10 + 8 customizable programs	
	Audio volume	Yes on wireless headphones	
	Display screen	8192 pixels	
	Backlighting	Yes, very low power consumption	
	Software updates	Yes, via USB / Internet connection	
	Wireless headphones	Yes (can also serve as control unit), weatherproof.	
	Coil	DD - 6 meters / 20 feet Waterproof - Wireless	
	Coil cover	Yes	
	General Features	Belt-mounted remote control case	Yes
		Headphones storage case	Yes
Stem		Fully telescopic, S-shaped	
Batteries		3 x Lithium ion polymer 630 mA (830mA HF coils)	
Battery level indicator		Yes: Remote control / Headphones / Coils / MI-6	
Remote control battery life		19 hours	
Wireless headphones battery life		22 hours	
Coil battery life		15 hours on average depending coils	
Mains power charger		Yes - rapid and simultaneous charging of all 3 elements. Input 100-200V 50/60Hz, Output 5V \approx 1A	
Field charger		Optional, with 1 AA battery & torch function	
Car cigarette lighter charger		Optional	
Charging time		Coil: 2h15 , Headphones/Remote control: 3h00	
Total weight with batteries		975g (875g without remote control)	
Total weight of stem		455 g	
Weight of remote control with battery		100 g	
Weight of headphones with battery		86 g (WS4), 255 g (WS5)	
Weight of coil		345 g with coil cover	
Length of folded stem		58 cm	
Length of deployed stem		130 cm	
Operating T°		-5°C to 40°C	
Max ambient T° during charging		0°C to 35°C	
Recommended storage T°		25°C	
Waterproof coil		Yes, but need the optional antenna for use with the coil submerged	
Guarantee	5 years parts and labour. Batteries, chargers & connectors have a 2 years warranty.		
Patents	US 7940049 B2 - EP 1990658 B1		



WS5



WS4



FX-01



Wristband WS4

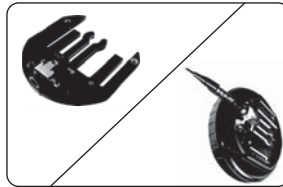

WS4 Clip jack adaptor
Connect your own
headphone



WS4 stem support



Coil 22.5 cm (9")



Coil 28 cm (11")



Coil 34 / 28 cm DD
(13"x11")



HF Coil 22.5 cm (9")



HF coil elliptical
24 x 13 cm (9.5" x 5")



Pinpointer MI-6



Car charger



Emergency charger with
with torch function
(AA battery (x1) not provided)



Solar charger



Hipmount case



Protective silicone case



Armband case



Kits: Waterproof armband 5 m +
Aerial antenna
(available in 1m15 et 2m50)



DEUS transport case

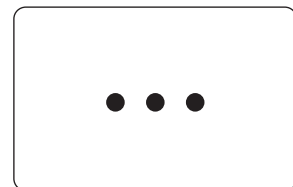

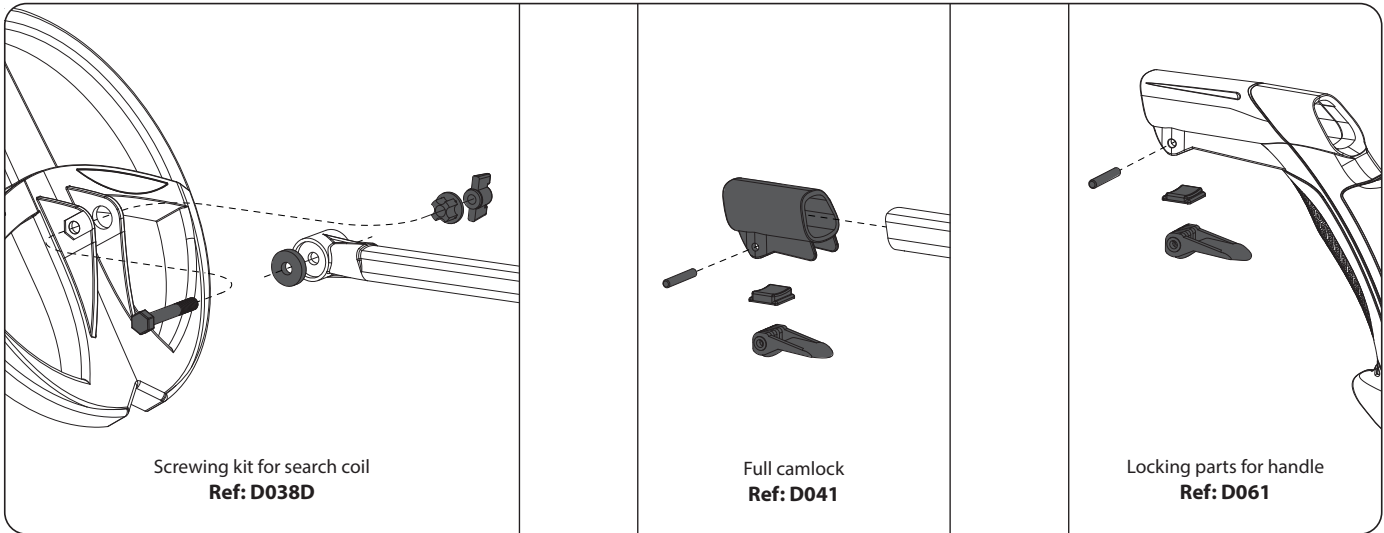
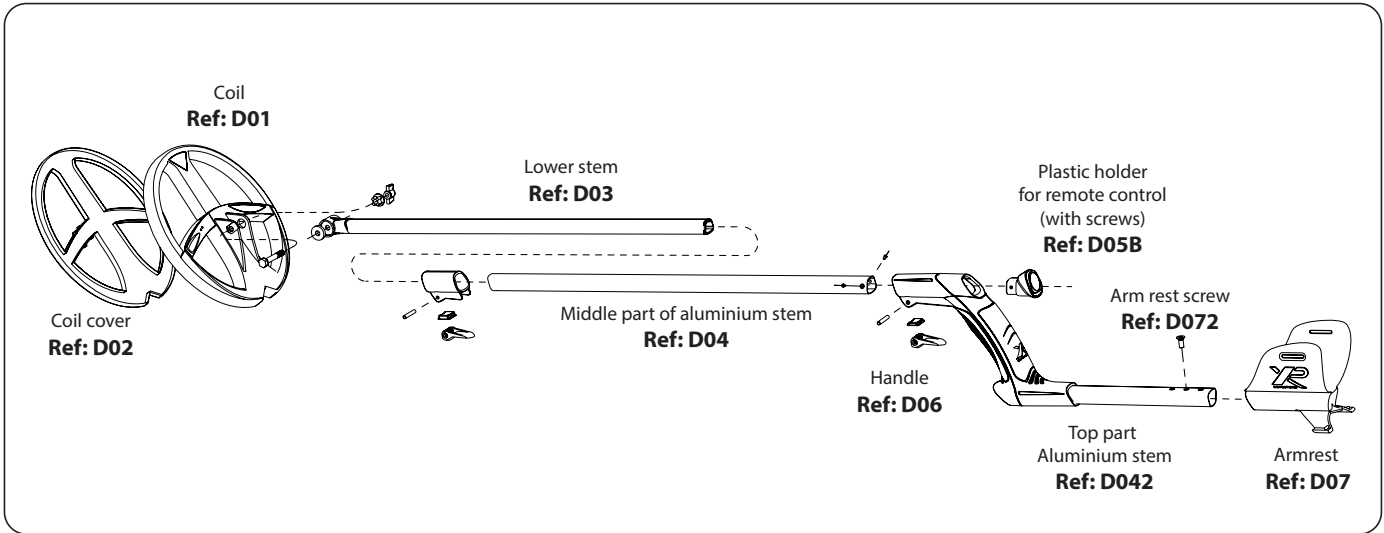

FULL REMOTE CONTROL - Ref: D08

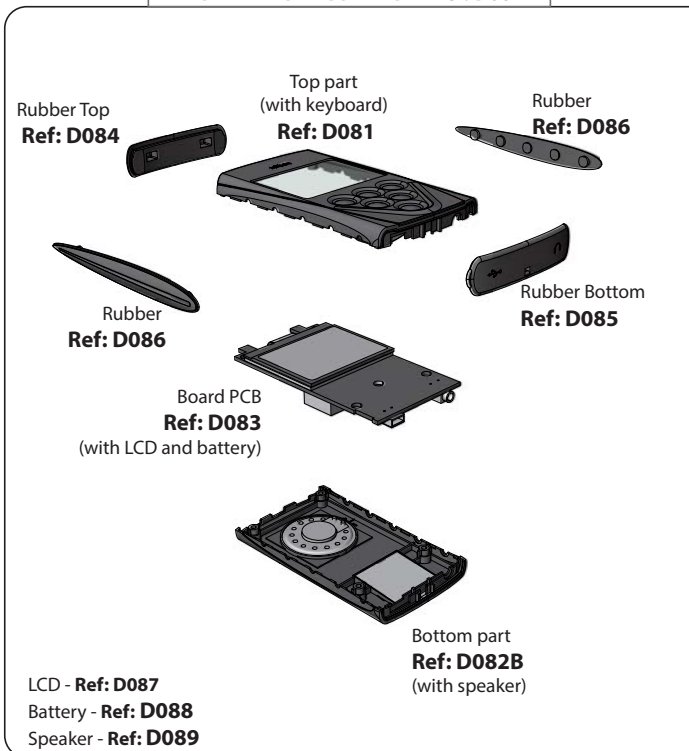

FULL HEADPHONES - Ref: D09



FACTORY PROGRAMS

General use

Mineralised grounds
Smalls targets

Mineralised and iron infested grounds
Smalls targets
Faster than GMPOWER

			program 1	program 2	program 3
MENU	MENU EXPERT	SETTINGS	BASIC	GM POWER	DEUS FAST
DISCRI	DISCRI (thrs 1 tone / 2 tones)	-6.4 to 99	10	6.1	6.1
	2 TONES	✓ switch on			
	3 TONES	✓ switch on	✓	✓	✓
	4 TONES	✓ switch on			
	5 TONES	✓ switch on			
	FULL TONES	✓ switch on			
	PITCH	✓ switch on			
	THRESHOLD 2T/ 3 TONES	0 to 99	76	76	76
	THRESHOLD 3T/ 4 TONES	0 to 99	84	84	84
	THRESHOLD 4T/ 5 TONES	0 to 99	92	92	92
	FREQUENCY TONE 1	100 to 993 Hz	202	202	202
	FREQUENCY TONE 2	100 to 993 Hz	518	518	518
	FREQUENCY TONE 3	100 to 993Hz	644	644	644
	FREQUENCY TONE 4	100 to 993 Hz	725	725	725
	FREQUENCY TONE 5	100 to 993 Hz	800	800	800
	FREQUENCY PITCH	150 to 603 Hz	362	362	362
SENSITIVITY		0 to 99	90	90	90
	TX POWER (DEUS)	1 to 3	2	2	2
FREQUENCY	DEPENDING COIL USED	4 to 80 kHz	12K	18K	18K
	FREQUENCY SHIFT	-1 to 1	0	0	0
IRON LEVEL		0 to 5	0	3	3
REACTIVITY		0 to 5	2	2	3
	SILENCER	-1 to 4	2	2	-1
AUDIO.R		0 to 7	4	4	4
NOTCH 1		00-00 to 99-99	00-00	00-00	00-00
	NOTCH 2	00-00 to 99-99	00-00	00-00	00-00
	NOTCH 3	00-00 to 99-99	00-00	00-00	00-00
GROUND	MANUAL	0-30(beach) 60-95(normal)	90	90	90
	BEACH	✓ switch on			
	TRACKING (Except beach mode)	✓ switch on			
	NOTCH GROUND	00-00 to 99-99			
THRESHOLD		0 to 20			
DiscrI IAR prog 10 only		0 to 5			

FACTORY PROGRAMS

General use
Audio signal
varies both in
amplitude and
height

For large
masses
and highly
conductive coins

Pro setting for
locating
deep targets,
with moderate
discrimination
and specific signal
processing.

More effective
for wet sand

More effective
for dry sand

The Pro setting
based on the Full
Tone audio mode
with a very low
discrimination.

Search of gold
nuggets in highly
mineralised soil -
All Metal
program

program 4	program 5	program 6	program 7	program 8	program 9	program 10
PITCH	G-MAXX	DEEP	WET BEACH	DRY BEACH	HOT	GOLD FIELD
6.1	6.1	5.5	10	10	-6.4	IAR 0
		✓				
	✓		✓			
				✓		
					✓	
✓						✓
76	76	76	76	76	76	
84	84	84	84	84	84	
92	92	92	92	92	92	
202	202	202	202	202	202	
518	518	710	518	518	518	
644	644	644	644	644	644	
725	725	725	725	725	725	
800	800	800	800	800	800	
362	362	362	362	362	362	362
90	90	90	85	90	90	95
2	2	3	1	2	2	2
12K	8K	8K	18K	18K	18K	18K
0	0	0	0	0	0	0
3	0	3	0	0	0	
2.5	1	2	3	2	3	2
-1	2	-1	-1	4	-1	
4	4	4	1	4	3	2
00-00	00-00	00-00	00-00	00-00	00-00	
00-00	00-00	00-00	00-00	00-00	00-00	
00-00	00-00	00-00	00-00	00-00	00-00	
90	90	88	27	90	90	90
			✓			
						0
						0

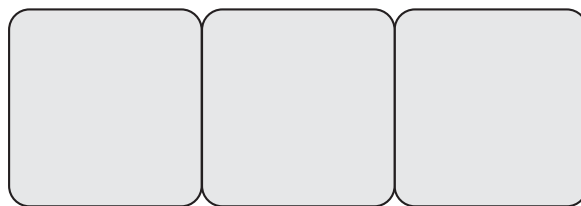

			program 11		
MENU	MENU EXPERT	SETTINGS			
DISCRI	DISCRI (thrs 1 tone / 2 tones)	- 6.4 to 99			
	2 TONES	✓ switch on			
	3 TONES	✓ switch on			
	4 TONES	✓ switch on			
	5 TONES	✓ switch on			
	FULL TONES	✓ switch on			
	PITCH	✓ switch on			
	THRESHOLD 2T/ 3 TONES	0 to 99			
	THRESHOLD 3T/ 4 TONES	0 to 99			
	THRESHOLD 4T/ 5 TONES	0 to 99			
	FREQUENCY TONE 1	100 to 993 Hz			
	FREQUENCY TONE 2	100 to 993 Hz			
	FREQUENCY TONE 3	100 to 993Hz			
	FREQUENCY TONE 4	100 to 993 Hz			
	FREQUENCY TONE 5	100 to 993 Hz			
	FREQUENCY PITCH	150 to 603 Hz			
SENSITIVITY		0 to 99			
	TX POWER (DEUS)	1 to 3			
FREQUENCY	DEPENDING COIL USED	4 to 80 kHz			
	FREQUENCY SHIFT	-1 to 1			
IRON LEVEL		0 to 5			
REACTIVITY		0 to 5			
	SILENCER	-1 to 4			
AUDIO.R		0 to 7			
NOTCH 1		00-00 to 99-99			
	NOTCH 2	00-00 to 99-99			
	NOTCH 3	00-00 to 99-99			
GROUND	MANUAL	0-30 _(beach) 60-95 _(normal)			
	BEACH	✓ switch on			
	TRACKING (Except beach mode)	✓ switch on			
	NOTCH GROUND	00-00 to 99-99			
THRESHOLD		0 to 20			
DiscrI IAR (prog 10 only)		0 to 5			

Detecting is an activity which, like other leisure activities, requires a few general guidelines. These recommendations will enable everyone to enjoy their hobby to the full while respecting laws, places, the environment and other people.

- Ensure you are informed of current legislation relating to discovery of treasure in order to abide by the law.
- Declare any fortuitous archaeological discoveries to the local authorities (town hall) of the discovery site within 48 hours.
- Before prospecting on a site, obtain permission from its owner(s) or guardian(s).
- Respect the natural environment in which you are prospecting and any other places to which you need access.
- Systematically back-fill any holes you make so as to leave a site exactly how you found it.
- Keep any rubbish you find in order to dispose of it in a dustbin.

Avoid detecting in areas where battles are known to have taken place during wartime. Exercise extreme caution with any suspect object resembling munitions, grenades, mines, shells, bombs, etc. and notify the relevant authorities (police, local authorities, etc.) of any such object you find.

Remember that you are an ambassador for metal detecting and it is important that you convey a positive image!

DECLARATION OF CONFORMITY



This declaration is made under the responsibility of the manufacturer:

XPLORER SARL - 8 rue du Développement – F-31320 CASTANET-TOLOSAN

We, XPLORER, hereby certify that this detector complies with the essential requirements of European R&TTE Directive no. 1999/5/EC, which aims to harmonise legislation in member states on the use of the radio spectrum, electromagnetic compatibility and electrical safety. Assessment of the device's compliance was carried out in accordance with the essential requirements of this directive and the harmonised standards:

SECURITY (art 3.1.a) : EN60950-1:2001 + A11, EN50366:2003 and EN50371:2002

EMC (art 3.1.b) : EN301489-3:V1.4.1, EN61326-1:1997 + A1 +A2 +A3, EN55011:2007

RADIO SPECTRUM (art 3. 2) : EN300440-1:V1.3.1, EN300440-2:V1.1.2

OTHERS : EN300330-1:V1.5.1

Declaration date : September 10th, 2009

For more information please contact:

XPLORER SARL - 8 rue du Développement – F-31320 CASTANET-TOLOSAN - FRANCE



THIS DEVICE COMPLIES WITH PART 15 OF THE FCC RULES. OPERATION IS SUBJECT TO THE FOLLOWING TWO CONDITIONS:

- (1) THIS DEVICE MAY NOT CAUSE HARMFUL INTERFERENCE, AND
- (2) THIS DEVICE MUST ACCEPT ANY INTERFERENCE RECEIVED, INCLUDING INTERFERENCE THAT MAY CAUSE UNDESIRE OPERATION.



This device complies with Industry Canada licence-exempt RSS standard(s). Operation is subject to the following two conditions:

- (1) this device may not cause interference, and
- (2) this device must accept any interference, including interference that may cause undesired operation of the device.

Safety relating to electromagnetic radio waves

This product complies with standards for user safety with regard to electromagnetic waves. The strength of the radio signals used is considerably weaker and on a much smaller scale than those emitted by mobile telephones (2,000 to 4,000 times weaker), as well as being much less than those used by Wi-Fi systems.

Moreover, when the complete system is used, the audio headphones only act as a passive radio receiver.

WARNING

The accessories delivered with these detectors may vary, and similarly the menus and certain features described in this manual may differ slightly from the product purchased.

This detector is not suitable for applications involving the search for dangerous targets such as munitions, mines, etc.

Recycling of electrical and electronic waste in the European Union and the other countries / regions in accordance with selective waste sorting procedures



If this symbol is displayed on the product or its packaging, it means that the product must not be disposed of with your household waste. You must take it to a designated collection point for recycling electrical and electronic waste. This selective waste sorting and recycling helps to preserve natural resources and avoid any potential risks for human health and the environment that could result from inappropriate scrapping, due to the possible presence of dangerous substances in the electric and electronic equipment. For more information on places where you can take your electrical waste, please contact the shop where you purchased this product.

Alternatively you can return it to your supplier, or directly to **XP**.

The same is true for the lithium batteries which must be recycled appropriately, or returned to your supplier or directly to **XP**.

© 2009 Xplorer sarl

This document contains information that is protected by existing legislation on copyright, brands and royalties.

Any reproduction, even partial, of this document, the logos or the XP and DĒus brands is prohibited without the agreement of:

**XPLORER SARL - 8 rue du Développement – F-31320 CASTANET-TOLOSAN
FRANCE**

XP DEUS - 5 YEARS LIMITED WARRANTY

- XP warrants that its products DEUS will be free from defects in materials or workmanship for 5 years.
- This contractual warranty for parts and labour takes effect from the initial date of purchase.

This warranty does not cover:

- Breakage caused by falls, impacts or accidental damage
- Damage caused by abnormal use or resulting from non-compliance with the conditions of use stipulated in the device's instructions
- Alteration of the electronic circuit by any unauthorized person.
- Using without coil cover, or using defective coil cover
- Corrosion of electronic circuits, due to water ingress
- A reduction in battery life due to battery ageing.
- Breakage of cables or wires

Spare parts are not cover by the 5 years warranty:

- Parts that are subject to normal wear and tear like: headphones earpads, coil bolts & fittings, cases etc... (These parts must be replaced in case of wear and tear, in such a way that no damage will be caused to the device).
- Batteries, chargers & connectors have a 2 years warranty.

In the event of any fault or malfunction please contact your XP dealer for advice, should any part require returning to them or the distributor it must be accompanied by a note explaining the fault, carriage/shipping cost is the customer's responsibility. Proof of Purchase is required to make a claim under this warranty. If a faulty device has been replaced by a new or reconditioned one, the warranty will continue from the original purchase date.

Contacts

Website : www.xpmetaldetectors.com

e-mail : info@xpmetaldetectors.com

XPLORES sarl
8 rue du développement
F-31320 CASTANET TOLOSAN
France
Tel : 33 (0)5.34431052
Fax : 33 (0)5.34431053

XP and Déus are trademarks of Xplorer sarl.

Xplorer reserves the right to modify its detectors' characteristics or specifications without notice.

After charging your device. (pg 29)



1
Switch on
the remote control

(after extending stems and holding the coil
away from the ground and any metal)



2
Validate or not the use
of the loudspeaker

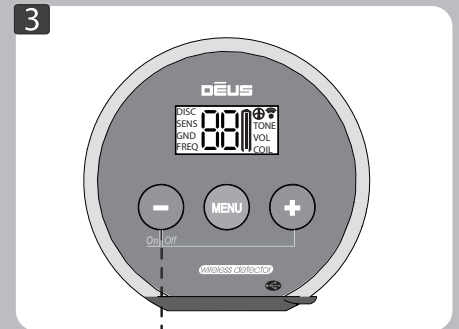

3
Switch on
the headphones

You're now ready for detecting!

By default you begin by using the 1 - BASIC factory program which is suitable for general use.

If you wish to test one of the 10 other factory programs,

simply scroll through them with



To switch off Dēus

1 Hold down Power for two seconds

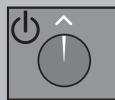

on the remote control

2 Press left and right buttons



on the headphone.

If you wish to change the main detection settings:

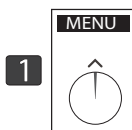

1 Press Menu

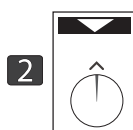

2 Press arrow to scroll
through the functions



3 Set with - / +

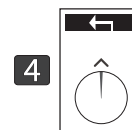

4 Press return arrow
to return to the main menu

Note Do not switch on Dēus when the coil is near metal , inside a car, or when the stem is collapsed, as this may interfere with calibration and lead to abnormal performance. If this should occur, switch Dēus off and move away from any metal masses before switching it on again. Nevertheless, this does not represent any risk to the equipment or its electronics. But may give abnormal results !